



Assembly Instructions for Grom Tuned Induction Kit (170-0802)

DISCLAIMER:

Many S&S parts are designed for high performance, closed course, racing applications and are intended for the very experienced rider only. The installation of S&S parts may void or adversely affect your factory warranty. In addition such installation and use may violate certain federal, state, and local laws, rules and ordinances as well as other laws when used on motor vehicles used on public highways. Always check federal, state, and local laws before modifying your motorcycle. It is the sole and exclusive responsibility of the user to determine the suitability of the product for his or her use, and the user shall assume all legal, personal injury risk and liability and all other obligations, duties, and risks associated therewith.

DISCLAIMER: NOT LEGAL FOR SALE OR USE IN CALIFORNIA ON ANY POLLUTION CONTROLLED MOTOR VEHICLE

*Qualified Manufacturer Declared 49-State Federal Emissions Compliant Part

SAFE INSTALLATION AND OPERATION RULES:

Before installing your new S&S part, it is your responsibility to read and follow the installation and maintenance procedures in these instructions and follow the basic rules below for your personal safety.

- Gasoline is extremely flammable and explosive under certain conditions and toxic when breathed. Do not smoke. Perform installation in a well ventilated area away from open flames or sparks.
- If motorcycle has been running, wait until engine and exhaust pipes have cooled down to avoid getting burned before performing any installation steps.
- Before performing any installation steps, disconnect battery to eliminate potential sparks and inadvertent engagement of starter while working on electrical components.
- Read instructions thoroughly and carefully so all procedures are completely understood before performing any installation steps. Contact S&S with any questions you may have if any steps are unclear or any abnormalities occur during installation or operation of motorcycle with an S&S part on it.
- Consult an appropriate service manual for your motorcycle for correct disassembly and reassembly procedures for any parts that need to be removed to facilitate installation.
- Use good judgment when performing installation and operating motorcycle. Good judgment begins with a clear head. Don't let alcohol, drugs or fatigue impair your judgment. Start installation when you are fresh.
- Be sure all federal, state and local laws are obeyed with the installation.
- For optimum performance and safety and to minimize potential damage to carb or other components, use all mounting hardware that is provided and follow all installation instructions.
- Motorcycle exhaust fumes are toxic and poisonous and must not be breathed. Run motorcycle in a well ventilated area where fumes can dissipate.

IMPORTANT NOTICE:

Statements in this instruction sheet preceded by the following words are of special significance.



WARNING

Means there is the possibility of injury to yourself or others.



CAUTION

Means there is the possibility of damage to the part or motorcycle.

NOTE

Other information of particular importance has been placed in italic type.

S&S recommends you take special notice of these items.

WARRANTY:

All S&S parts are guaranteed to the original purchaser to be free of manufacturing defects in materials and workmanship for a period of twelve (12) months from the date of purchase. Merchandise that fails to conform to these conditions will be repaired or replaced at S&S's option if the parts are returned to us by the purchaser within the 12 month warranty period or within 10 days thereafter.

In the event warranty service is required, the original purchaser must call or write S&S immediately with the problem. Some problems can be rectified by a telephone call and need no further course of action.

A part that is suspect of being defective must not be replaced by a Dealer without prior authorization from S&S. If it is deemed necessary for S&S to make an evaluation to determine whether the part was defective, a return authorization number must be obtained from S&S. The parts must be packaged properly so as to not cause further damage and be returned prepaid to S&S with a copy of the original invoice of purchase and a detailed letter outlining the nature of the problem, how the part was used and the circumstances at the time of failure. If after an evaluation has been made by S&S and the part was found to be defective, repair, replacement or refund will be granted.

ADDITIONAL WARRANTY PROVISIONS:

- (1) S&S shall have no obligation in the event an S&S part is modified by any other person or organization.
- (2) S&S shall have no obligation if an S&S part becomes defective in whole or in part as a result of improper installation, improper maintenance, improper use, abnormal operation, or any other misuse or mistreatment of the S&S part.
- (3) S&S shall not be liable for any consequential or incidental damages resulting from the failure of an S&S part, the breach of any warranties, the failure to deliver, delay in delivery, delivery in non-conforming condition, or for any other breach of contract or duty between S&S and a customer.

Tools needed:

- 5mm Allen Wrench or Allen socket
- 4mm Allen Wrench or Allen Socket
- 3mm Allen Wrench or Allen Socket
- 10mm 6pt socket
- Ratchet and Extension
- Phillips Screwdriver - Standard length
- Phillips Screwdriver - Short or Stubby length
- Flat Screwdriver
- Side Cutter, shear or similar (for cutting breather hose)
- Needle nose pliers (optional - useful for getting breather hose on barb and dealing with breather hose clamps)

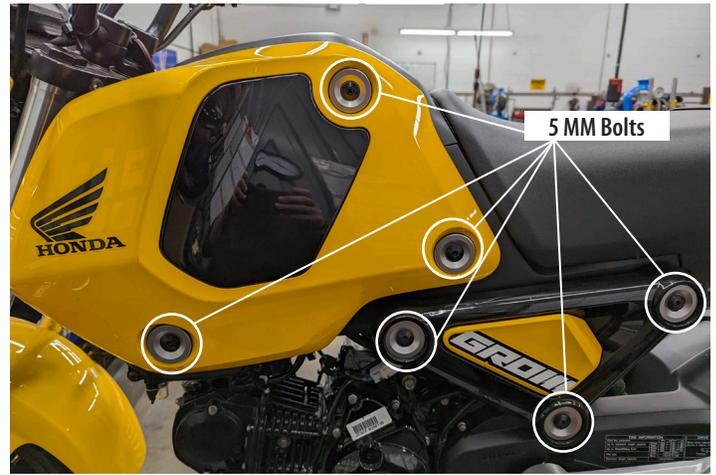

Picture 2

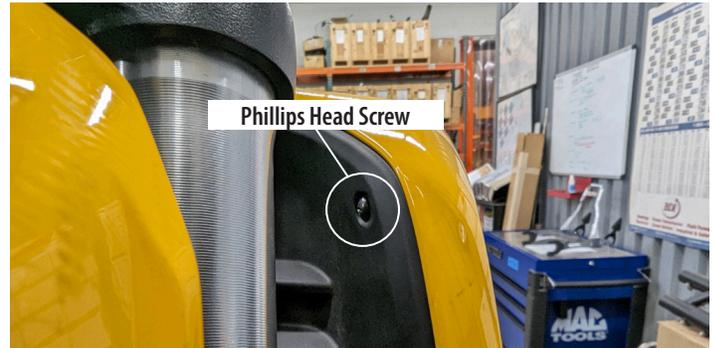

Picture 3



Picture 4

Installation

1. Remove side shrouds on both sides using 5mm allen (Pictures 1 & 2). Use a short Phillips screwdriver to remove 2x screws on each side holding the inner shroud to the outer shroud (Picture 3). Carefully pull out on the bottom of the covers to release the bottom clip. Rear triangular cover removal is optional. Removing allows more flexibility of plastic underneath but is not necessary.

2. Loosen OEM induction clamp on throttle body.



Picture 1



Picture 5

3. Remove pan head screws from inner tank covers to airbox. There are 3 on the left (Picture 6) and 1 on the right (Picture 7).



Picture 6



Picture 7

4. Flex left side tank cover out and reach in to disconnect sensor wiring. (See Picture 8)



Picture 8

5. Use a 10mm socket and extension to remove the airbox mount screw on both sides of the bike (Pictures 9 & 10). Work the OEM induction tube off the throttle body and lower the airbox until free (See Picture 11). Disconnect the crankcase breather line from the OEM airbox and hoses that snap onto the induction tube and ensure they are free.

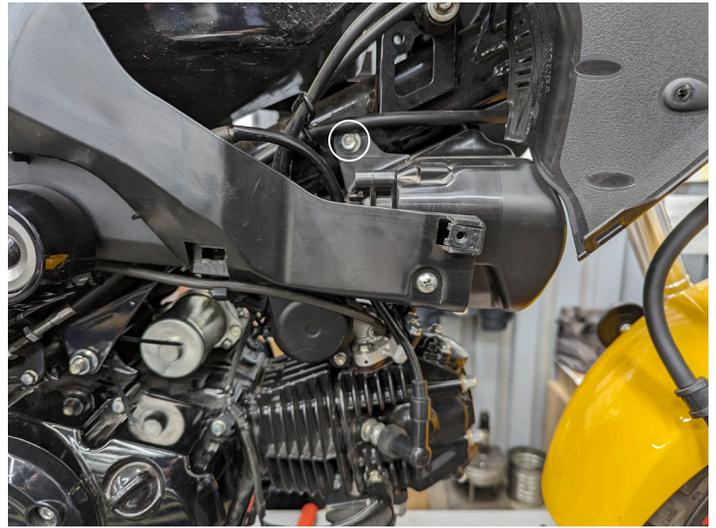

Picture 9

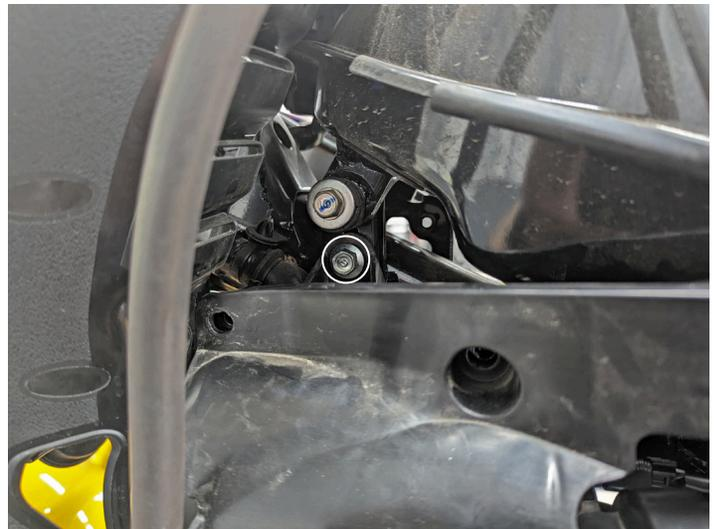

Picture 10

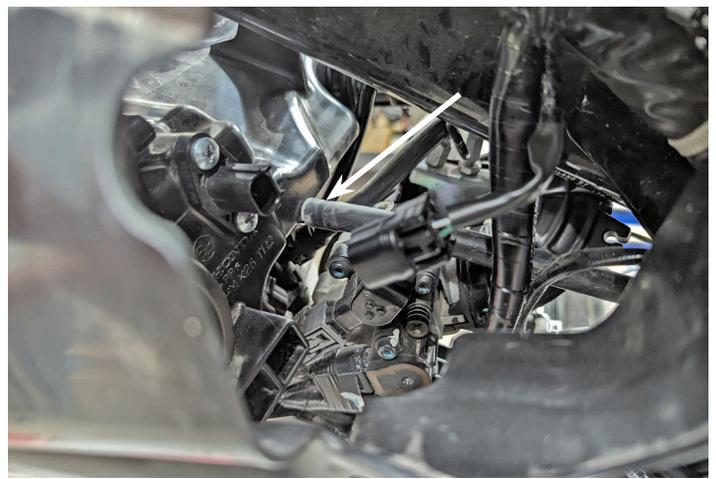

Picture 11

6. Remove sensor from OEM airbox with phillips screwdriver (Picture 13). Inspect o-ring on sensor and replace if damaged. Work rubber intake tube side to side to break sealant bond from the air box and pull firmly to remove (Picture 14).



Picture 12



Picture 15

7. Using 4mm allen, remove OEM screw for the throttle cover (Picture 16)



Picture 13



Picture 16

8. Prepare S&S Tuned Induction for installation. Install the sensor being mindful of orientation (Picture 17). Carefully install OEM sensor screws making sure they are straight. Tighten until snug, do not overtighten. Install provided M6 lock nut and screw (Pictures 18&19). Install provided M5 button head cap screw into mount boss (Picture 20).



Picture 14



Picture 17



Picture 18

9. Install the provided o-ring into the groove on the throttle body (Picture 21). Trim about 3 to 3 1/4 inches from the end of the breather tube, placing the OEM spring clamp back on the trimmed end (Picture 22).



Picture 21



Picture 19



Picture 22

10. Reinstall the OEM airbox with the OEM screws and a 10mm socket. Torque to OEM specifications.



Picture 20

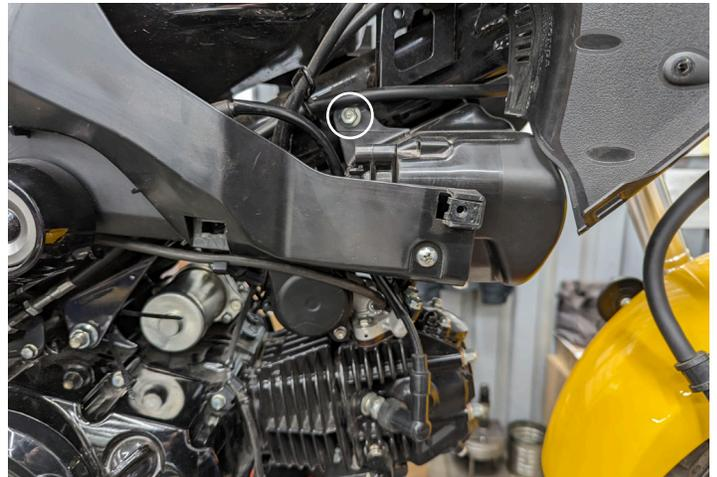

Picture 23

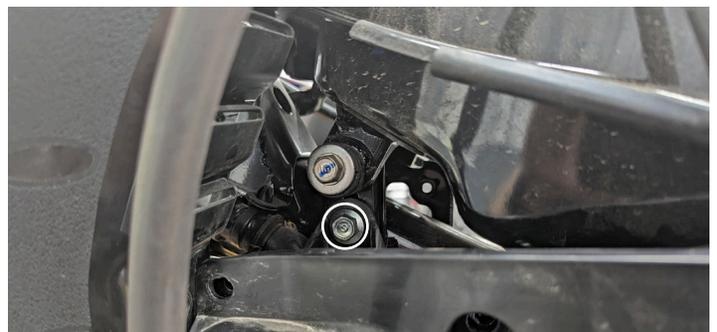

Picture 24

11. Install S&S Tuned Induction from the right side of the bike, being careful not to pinch the o-ring on the throttle body. Align throttle cover and the M5 button head cap screw and using a 3mm allen tighten finger tight. Ensure the induction is fully seated on the throttle body and tighten the clamp screw with a 4mm allen to 10-12 i n-lbs. Tighten the M5 button head screw to 12 in-lbs.
12. Install breather hose ensuring it is fully seated against the boss. Place clamp $\frac{1}{4}$ " from end of hose.



Picture 28



Picture 29



Picture 25

13. Install sensor wiring. Install phillip screws in tank covers to OEM airbox. Reinstall covers and shrouds according to OEM specifications.

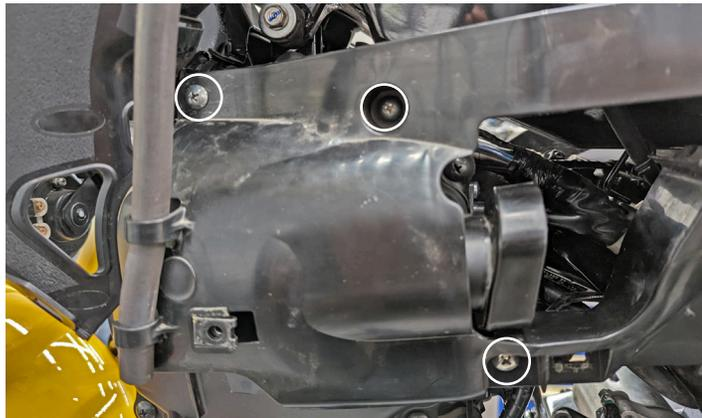

Picture 26

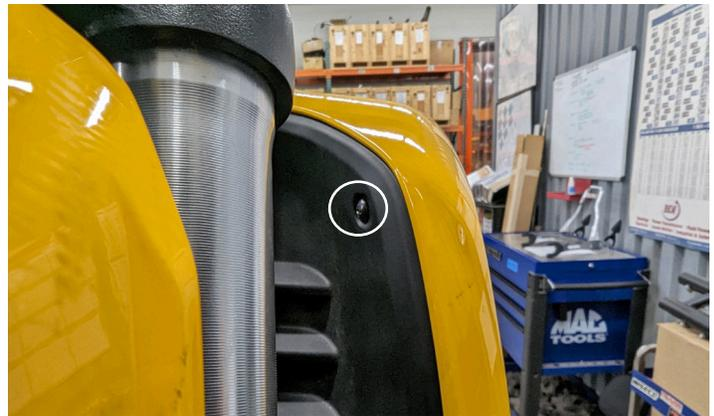

Picture 30

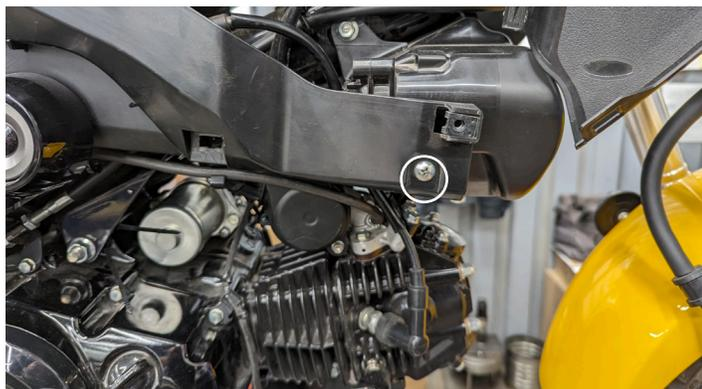

Picture 27

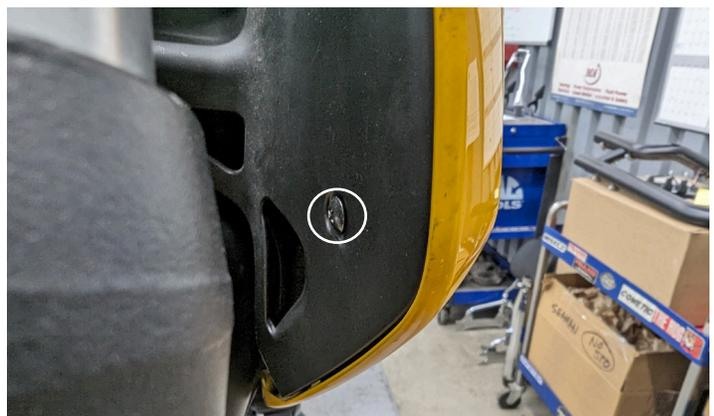

Picture 31

14. Position clamp on S&S filter as shown, and install on S&S Tuned Induction until fully seated. Using a flat screwdriver, tighten the clamp tucking loose end under the clamp cover. Hose clamp should not be visible upon final inspection.



Picture 32



Picture 33



Picture 34

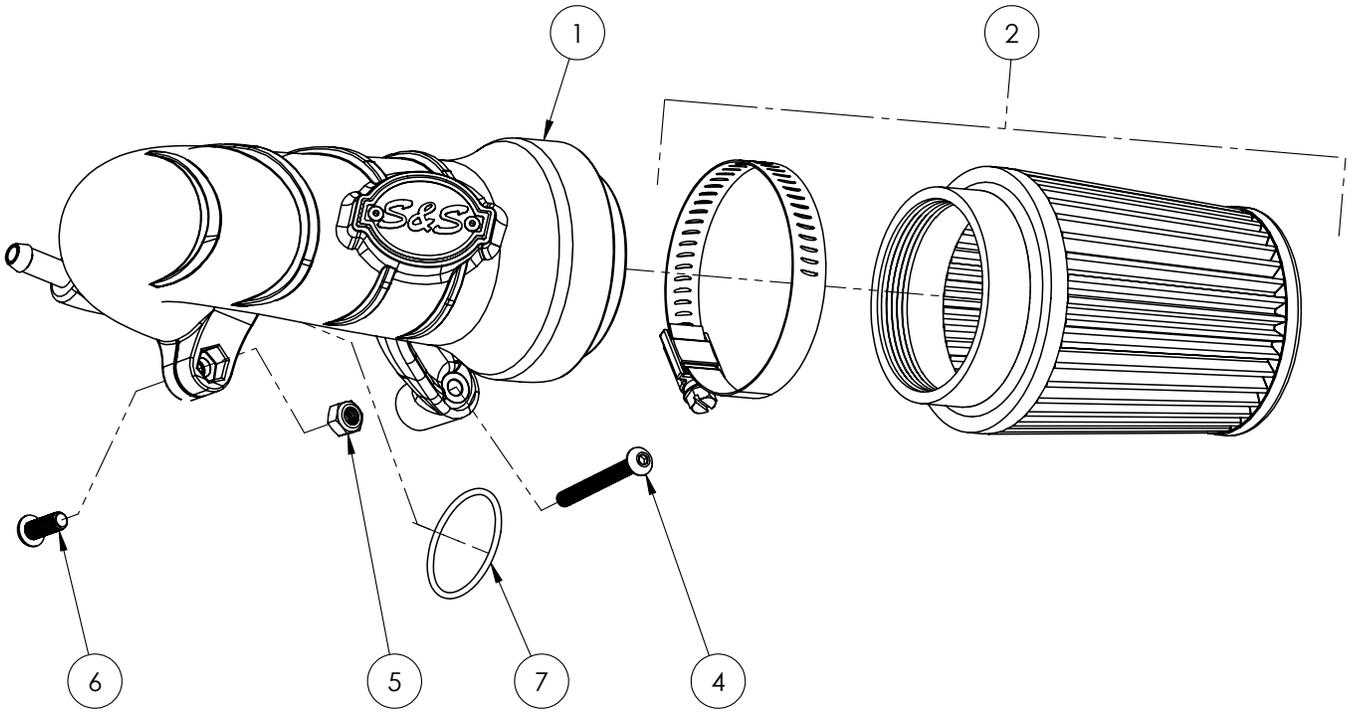

1. Tuned induction Intake	170-0801
2. Air Filter	170-0559
3. Hardware Kit.....	170-0799
4. BHC Screw.....	500-1837
5. Lock Nut.....	500-1838
6. BHC Screw.....	500-1196
7. O-Ring.....	500-1840