

Instruction 510-0391D

07-01-2020

Version 1

© 2020

by S&S® Cycle, Inc.

All rights reserved.
Printed in the U.S.A.

S&S® Cycle, Inc.

14025 Cty Hwy G

Viola, Wisconsin 54664

Phone: 608-627-1497

Technical Service Email: sstech@sscycycle.com

Website: www.sscycle.com



S&S Teardrop Installation Instructions for Fuel Injected Harley-Davidson® Big Twin and Sportster® Models (Not For Models With Electronic Throttle Control)

DISCLAIMER:

Many S&S parts are designed for high performance, closed course, racing applications and are intended for the very experienced rider only. The installation of S&S parts may void or adversely affect your factory warranty. In addition such installation and use may violate certain federal, state, and local laws, rules and ordinances as well as other laws when used on motor vehicles used on public highways. Always check federal, state, and local laws before modifying your motorcycle. It is the sole and exclusive responsibility of the user to determine the suitability of the product for his or her use, and the user shall assume all legal, personal injury risk and liability and all other obligations, duties, and risks associated therewith.

Exempt from emissions tampering regulations on 2001–2020 fuel injected non-CVO models under CARB EO# D-355-30.

SAFE INSTALLATION AND OPERATION RULES:

Before installing your new S&S part it is your responsibility to read and follow the installation and maintenance procedures in these instructions and follow the basic rules below for your personal safety.

- Gasoline is extremely flammable and explosive under certain conditions and toxic when breathed. Do not smoke. Perform installation in a well ventilated area away from open flames or sparks.
- If motorcycle has been running, wait until engine and exhaust pipes have cooled down to avoid getting burned before performing any installation steps.
- Before performing any installation steps disconnect battery to eliminate potential sparks and inadvertent engagement of starter while working on electrical components.
- Read instructions thoroughly and carefully so all procedures are completely understood before performing any installation steps. Contact S&S with any questions you may have if any steps are unclear or any abnormalities occur during installation or operation of motorcycle with a S&S part on it.
- Consult an appropriate service manual for your motorcycle for correct disassembly and reassembly procedures for any parts that need to be removed to facilitate installation.
- Use good judgment when performing installation and operating motorcycle. Good judgment begins with a clear head. Don't let alcohol, drugs or fatigue impair your judgment. Start installation when you are fresh.
- Be sure all federal, state and local laws are obeyed with the installation.
- For optimum performance and safety and to minimize potential damage to carb or other components, use all mounting hardware that is provided and follow all installation instructions.
- Motorcycle exhaust fumes are toxic and poisonous and must not be breathed. Run motorcycle in a well ventilated area where fumes can dissipate.

IMPORTANT NOTICE:

Statements in this instruction sheet preceded by the following words are of special significance.



WARNING

Means there is the possibility of injury to yourself or others.

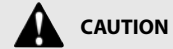

CAUTION

Means there is the possibility of damage to the part or motorcycle.

NOTE

Other information of particular importance has been placed in italic type.

S&S recommends you take special notice of these items.

WARRANTY:

All S&S parts are guaranteed to the original purchaser to be free of manufacturing defects in materials and workmanship for a period of twelve (12) months from the date of purchase. Merchandise that fails to conform to these conditions will be repaired or replaced at S&S's option if the parts are returned to us by the purchaser within the 12 month warranty period or within 10 days thereafter.

In the event warranty service is required, the original purchaser must call or write S&S immediately with the problem. Some problems can be rectified by a telephone call and need no further course of action.

A part that is suspect of being defective must not be replaced by a Dealer without prior authorization from S&S. If it is deemed necessary for S&S to make an evaluation to determine whether the part was defective, a return authorization number must be obtained from S&S. The parts must be packaged properly so as to not cause further damage and be returned prepaid to S&S with a copy of the original invoice of purchase and a detailed letter outlining the nature of the problem, how the part was used and the circumstances at the time of failure. If after an evaluation has been made by S&S and the part was found to be defective, repair, replacement or refund will be granted.

ADDITIONAL WARRANTY PROVISIONS:

- (1) S&S shall have no obligation in the event an S&S part is modified by any other person or organization.
- (2) S&S shall have no obligation if an S&S part becomes defective in whole or in part as a result of improper installation, improper maintenance, improper use, abnormal operation, or any other misuse or mistreatment of the S&S part.
- (3) S&S shall not be liable for any consequential or incidental damages resulting from the failure of an S&S part, the breach of any warranties, the failure to deliver, delay in delivery, delivery in non-conforming condition, or for any other breach of contract or duty between S&S and a customer.
- (4) S&S parts are designed exclusively for use in Harley-Davidson® and other American v-twin motorcycles. S&S shall have no warranty or liability obligation if an S&S part is used in any other application.

INSTALLATION FOR BIG TWIN

1. Remove stock air cleaner cover and backplate assembly, retain stock gasket between backplate and throttle body/carburetor.
2. Select the breather fittings with the correct threads for your engine. 1991-'16 Sportster® and 1993-'99 big twin models use 1/2-13 thread. 1999-'16 big twin models use 3/8-16 thread. Assemble head breather assembly with parts in order as shown in **Picture 1** from left to right. Install in cylinder head as shown in **Picture 2**, and tighten to 16 ft/lb.

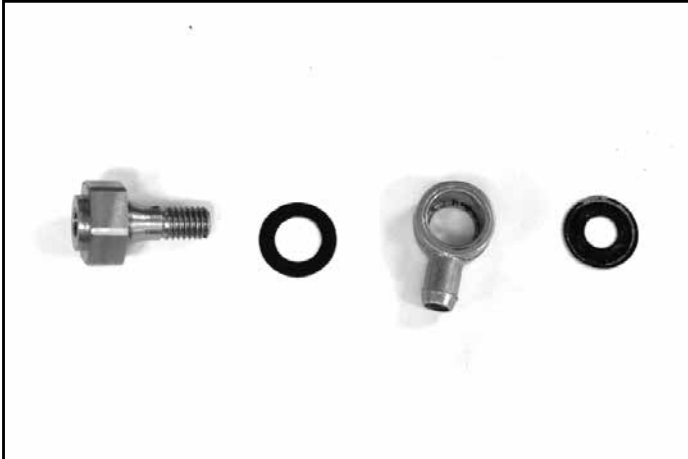

Picture 1



Picture 3



Picture 4

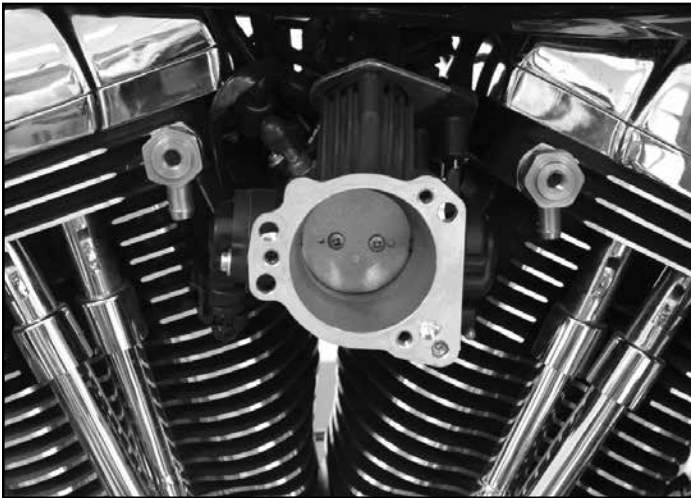

Picture 2



Picture 5

3. Install adapter plate on throttle body/carburetor. Place stock gasket on first followed by adapter plate as shown in **Picture 3** and three slotted screws. The orientation of the bracket should be with the counter bore facing outward and hose fittings at the four and eight o'clock positions, **See Picture 4**. Apply blue threadlock to screws and tighten to 6 ft-lbs.
4. Install breather hoses. Use spring clip to secure hose to head breather fitting and plastic tie strap on adapter plate fitting. **See Pictures 5 and 6**.



Picture 6

5. Place gasket on S&S® backplate as shown in **Picture 7**. Apply blue thread locker to three slotted screws install on motorcycle. Insert outer breather screws through ears of backplate and torque to 16 ft-lbs. **See Picture 8.**
6. Install air filter on the backplate. Place teardrop cover over filter. Apply blue threadlock to the three Phillips head screws, and fasten cover to backplate. **See Pictures 9 and 10.**
7. Apply the CARB EO label to the frame down tube above or below the factory label. Do not cover up any portion of the factory label. **See Picture 11.**



Picture 10

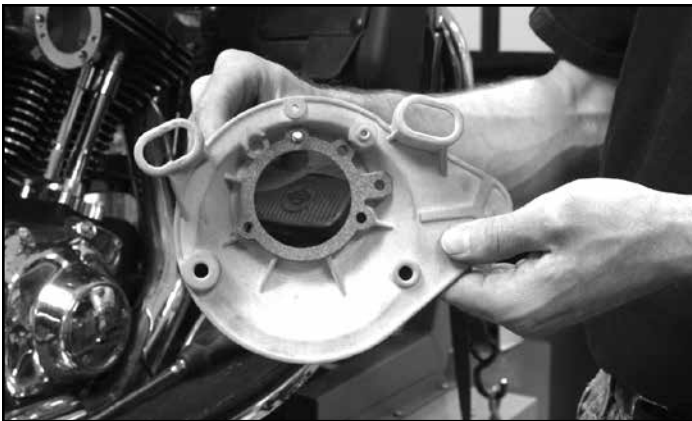

Picture 7



Picture 11



Picture 8



Picture 9

INSTALLATION FOR HARLEY-DAVIDSON® SPORTSTER® MODELS

1. Follow steps 1-4 for big twin installation.
2. Install backplate support bracket (S shaped bracket) on front and rear breather bolts in a vertical position using head breather screws. These brackets are installed with the bend facing out.

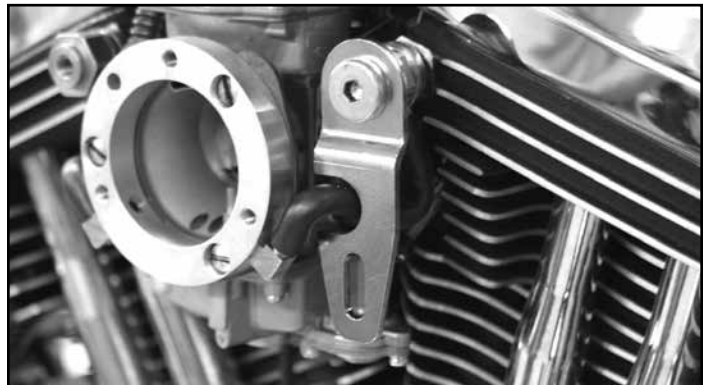

Picture 12

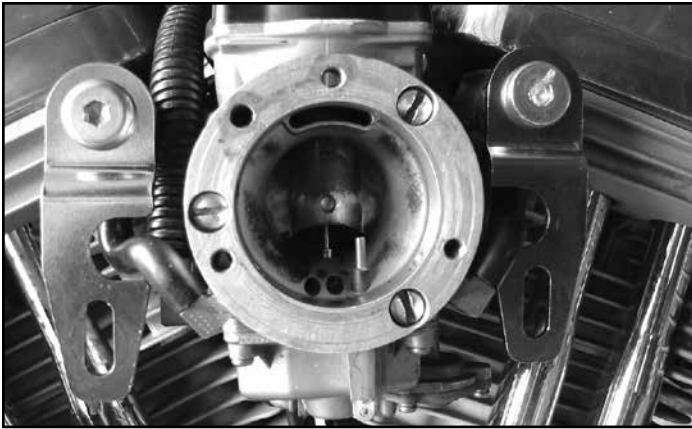

Picture 13

Tighten to 16 ft-lbs. See Pictures 12 and 13

- 3. Place gasket on S&S® backplate as shown in **Picture 14**, and install on motorcycle with three slotted screws. Be sure to use blue

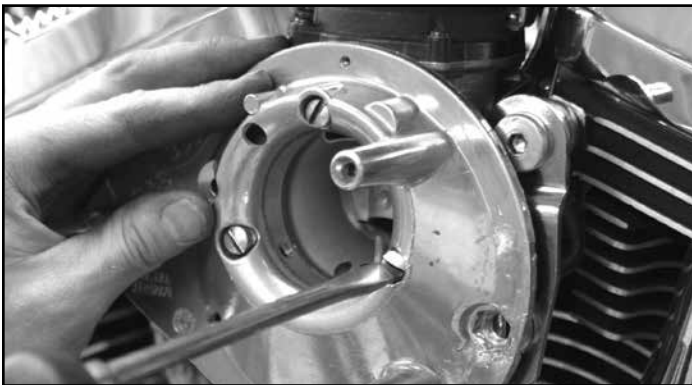

Picture 14

threadlock.

- 4. Be sure intake assembly is level and install mounting hardware from backplate to support brackets. The front bracket will use a $\frac{5}{16}$ "-18 x 1" bolt, $\frac{5}{16}$ " spacers then a flat washer and locknut. The rear bracket uses a $\frac{5}{16}$ "-18 x 1" flat head socket head cap screw, the $\frac{1}{2}$ " ID x .250" thick x 1" OD washer, then the $\frac{5}{16}$ " flat washer and $\frac{5}{16}$ "-18 locknut. See Pictures 15 and 16.
- 5. Install air filter on the backplate. Place teardrop cover over filter. Apply blue threadlock to the three Phillips head screws, and fasten cover to backplate. See Pictures 17 and 18.
- 6. Apply the CARB EO label to the frame down tube above or below the factory label. Do not cover up any portion of the factory label. See Picture 11 on page 3.

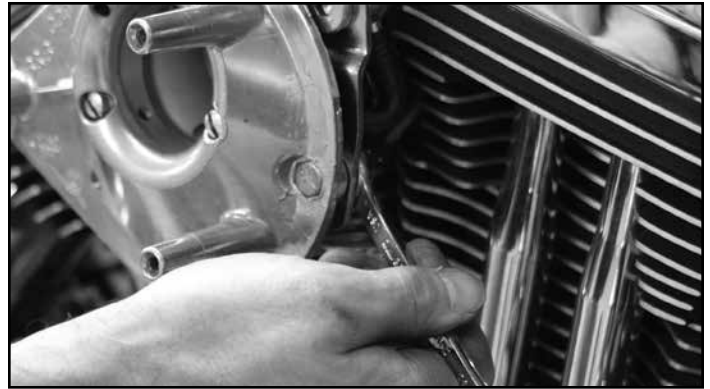

Picture 15



Picture 16



Picture 17



Picture 18

Replacement Parts For S&S Teardrop Air Cleaners (See line drawing on next page)

1. Air cleaner cover		13. Breather screw seal	
Chrome	17-0378	BT – Washer, .380"	
Gloss Black	170-0384A	(each).....	50-7054
Slasher	17-0004	10 pack.....	50-7059
2. Cover screw,		XL – Washer, .520"	
Chrome (H-D® #1305)		(each).....	50-7055
(each).....	50-0072	10 pack.....	50-7057
3 pack.....	50-1052	14. Breather fitting	
10 pack.....	50-0094	(each).....	17-0350
Black (H-D® #902)		2 pack	17-0355
(each).....	50-0310-S	15. Screw, Backplate, Socket Panhead, Alloy Steel	17-0346
3 pack.....	50-0310	16. Hose, vent, breather, formed,	
3. Filter Element, Pleated	106-4722	BT (each)	17-0364A
4. Backplate,		XL (each)	106-0161A
1993-'06 bt, stock CV/Delphi® EFI	106-0907	Screw, Breather vent	
1991-2007 XL.....	106-0950	BT (each)	17-0348
5. Backplate screw, BT 1999-up, All 2002-up EFI BT,Zinc Plated		XL (each)	106-0845
(each).....	106-2084	17. Screw, Backplate Socket Panhead	
10 pack	106-2105	5/16-24 x .360", Zinc, Alloy Steel	17-0346
6. Support bracket screw, 5/16"-18 x 1 1/4"	50-0110	18. Gasket, backplate	
7. Bracket, support, air cleaner to head, xl, 1991-up		(each).....	106-1724
Front	17-0305	10 pack	106-2328
Rear	106-1285	19. Adaptor assembly,	
8. Washer, flat 5/16" x 11/16" x 1/8"	50-7033	1993-'06 bt	106-0881
9. Nut, lock, HH, 5/16"-18.....	50-5021	1991-up XL.....	106-1982
10. Backplate plug 1/8"-27 (H-D® #45830-48)		20. Clamp, spring, 9/16"	50-8001
(each).....	50-8331A	21. Wire tie (N/S)	50-8003
10 pack	50-1015	(N/S) = Not Shown	
11. Shims			
58" x .025"			
(each).....	50-7113		
10 pack.....	50-7110		
58" x .050"			
(each).....	50-7114		
10 pack.....	50-7111		
58" x .075"			
(each).....	50-7115		
10 pack.....	50-7112		
12. Shim kit, XL 1966-'87	17-0314		
(Includes 2 each 5/16" x .018", 5/16" x .030", 5/16" x .048", 5/16"x .105" and 4 each 5/16" x .125")			
Replacement shims			
5/16" x .018"			
(each).....	50-7038		
5/16" x .030"			
(each).....	50-7039		
5/16" x .048"			
(each).....	50-7040		
5/16" x .105"			
(each).....	50-7041		
5/16" x .125"			
(each).....	50-7042		
2 pack.....	50-7042P		

EFI Big Twin (except throttle by wire)

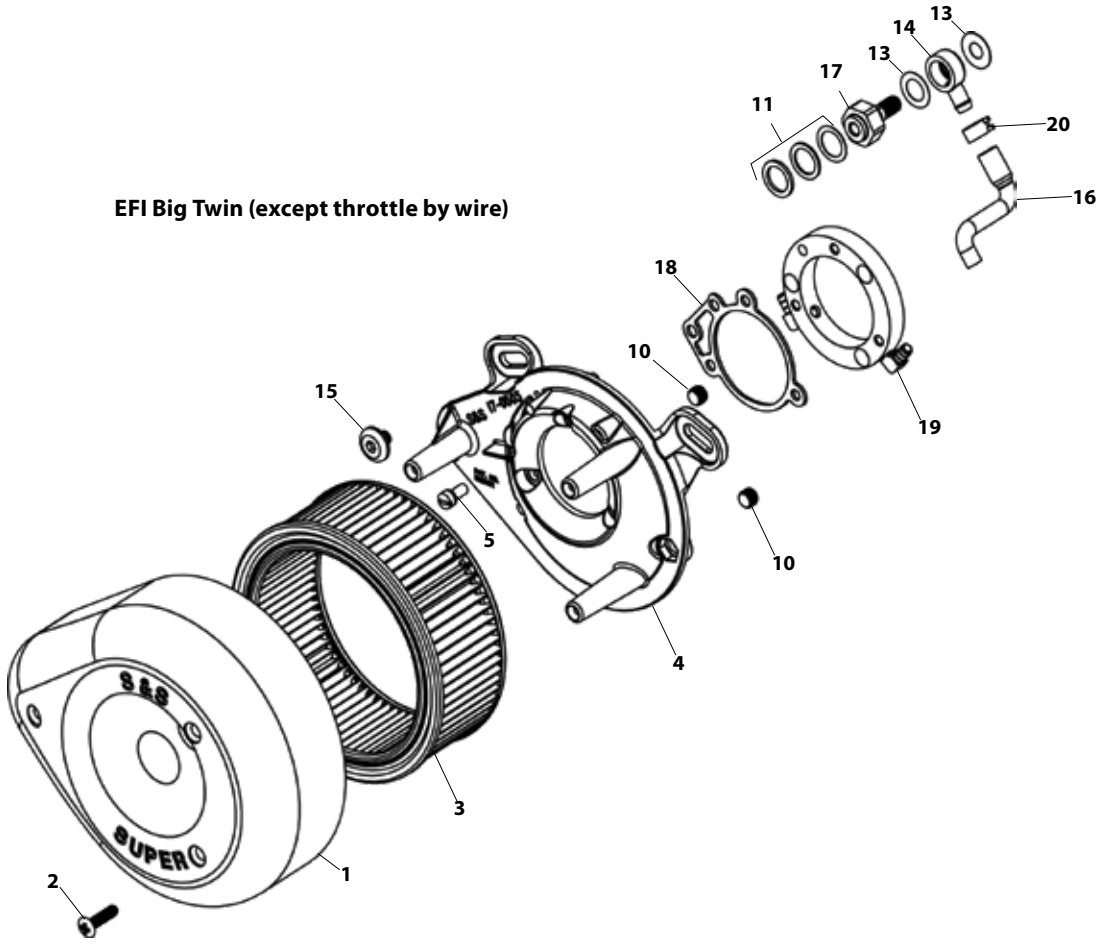

Sportster® Models

