



Copyright © 2011, 2013, 2017

by S&S Cycle, Inc.

All rights reserved.

Printed in the U.S.A.

## Installation Instructions for S&S<sup>®</sup> Standard Billet Oil Pump for 1936-'99 Harley-Davidson<sup>®</sup> Big Twin Engines

### DISCLAIMER:

S&S parts are designed for high performance, closed course, racing applications and are intended for the very experienced rider only. The installation of S&S parts may void or adversely affect your factory warranty. In addition such installation and use may violate certain federal, state, and local laws, rules and ordinances as well as other laws when used on motor vehicles used on public highways, especially in states where pollution laws may apply. Always check federal, state, and local laws before modifying your motorcycle. It is the sole and exclusive responsibility of the user to determine the suitability of the product for his or her use, and the user shall assume all legal, personal injury risk and liability and all other obligations, duties, and risks associated therewith.

The words Harley<sup>®</sup>, Harley-Davidson<sup>®</sup>, H-D<sup>®</sup>, Sportster<sup>®</sup>, Evolution<sup>®</sup>, and all H-D part numbers and model designations are used in reference only. S&S Cycle is not associated with Harley-Davidson, Inc.

### SAFE INSTALLATION AND OPERATION RULES:

Before installing your new S&S part it is your responsibility to read and follow the installation and maintenance procedures in these instructions and follow the basic rules below for your personal safety.

- Gasoline is extremely flammable and explosive under certain conditions and toxic when breathed. Do not smoke. Perform installation in a well ventilated area away from open flames or sparks.
- If motorcycle has been running, wait until engine and exhaust pipes have cooled down to avoid getting burned before performing any installation steps.
- Before performing any installation steps disconnect battery to eliminate potential sparks and inadvertent engagement of starter while working on electrical components.
- Read instructions thoroughly and carefully so all procedures are completely understood before performing any installation steps. Contact S&S with any questions you may have if any steps are unclear or any abnormalities occur during installation or operation of motorcycle with a S&S part on it.
- Consult an appropriate service manual for your motorcycle for correct disassembly and reassembly procedures for any parts that need to be removed to facilitate installation.
- Use good judgment when performing installation and operating motorcycle. Good judgment begins with a clear head. Don't let alcohol, drugs or fatigue impair your judgment. Start installation when you are fresh.
- Be sure all federal, state and local laws are obeyed with the installation.
- For optimum performance and safety and to minimize potential damage to carb or other components, use all mounting hardware that is provided and follow all installation instructions.
- Motorcycle exhaust fumes are toxic and poisonous and must not be breathed. Run motorcycle in a well ventilated area where fumes can dissipate.

### IMPORTANT NOTICE:

Statements in this instruction sheet preceded by the following words are of special significance.



**WARNING**

Means there is the possibility of injury to yourself or others.



**CAUTION**

Means there is the possibility of damage to the part or motorcycle.

**NOTE**

*Other information of particular importance has been placed in italic type. S&S recommends you take special notice of these items.*

### WARRANTY:

All S&S parts are guaranteed to the original purchaser to be free of manufacturing defects in materials and workmanship for a period of twelve (12) months from the date of purchase. Merchandise that fails to conform to these conditions will be repaired or replaced at S&S's option if the parts are returned to us by the purchaser within the 12 month warranty period or within 10 days thereafter.

In the event warranty service is required, the original purchaser must call or write S&S immediately with the problem. Some problems can be rectified by a telephone call and need no further course of action.

A part that is suspect of being defective must not be replaced by a Dealer without prior authorization from S&S. If it is deemed necessary for S&S to make an evaluation to determine whether the part was defective, a return authorization number must be obtained from S&S. The parts must be packaged properly so as to not cause further damage and be returned prepaid to S&S with a copy of the original invoice of purchase and a detailed letter outlining the nature of the problem, how the part was used and the circumstances at the time of failure. If after an evaluation has been made by S&S and the part was found to be defective, repair, replacement or refund will be granted.

### ADDITIONAL WARRANTY PROVISIONS:

- (1) S&S shall have no obligation in the event an S&S part is modified by any other person or organization.
- (2) S&S shall have no obligation if an S&S part becomes defective in whole or in part as a result of improper installation, improper maintenance, improper use, abnormal operation, or any other misuse or mistreatment of the S&S part.
- (3) S&S shall not be liable for any consequential or incidental damages resulting from the failure of an S&S part, the breach of any warranties, the failure to deliver, delay in delivery, delivery in non-conforming condition, or for any other breach of contract or duty between S&S and a customer.

**Introduction**

Read instructions completely and become thoroughly familiar with entire installation procedure before starting. See **Chart 1** to confirm that you have the correct oil pump kit for your application.. All S&S® oil pump kits are listed with the specific year groups they fit followed by steps required for standard installation of that particular pump kit. Some kits have optional steps listed that may be performed to update early oiling systems to later specifications for improved performance. Read following notes to determine if optional steps are desired.

*NOTE: S&S® crankcases require no modification for S&S oil pumps. . S&S 1970-'99 alternator style crankcases are machined for either 1981-1991 or 1992-up oil pump as specified at time of order.*

| Pump Kit Part No. | Year Group                           | Required Steps             | Optional Steps      |
|-------------------|--------------------------------------|----------------------------|---------------------|
| 31-6200           | 1936-'69                             | 1,7,8,9                    | 4 (1948-'62 only) § |
| 31-6203           | 1970-'91                             | 1,2,3,6 (1970-'72)‡, 7,8,9 |                     |
| 31-6205           | 1984-up S&S®/1992-up HD®             | 1,7,8,9                    |                     |
| 31-6206           | 1992-up HD®                          | 1,7,8,9                    |                     |
| 31-6292           | 1948-'53                             | 1,7,8,9                    |                     |
| 31-6293           | 1954-'69                             | 1,7,8,9                    |                     |
| 31-6294           | 1970-'77                             | 1,2,3,6 (1970-'72), 7,8,9  | 5 (1970-'72 only) § |
| 31-6295           | 1978-'91                             | 1,3,7,8,9                  |                     |
| 31-6296 †         | 1992-up w/pre-'89 style pinion shaft | 1,7,8,9                    |                     |

§ S&S® recommends this optional step be performed only if engine has been modified to run an end oiling pinion shaft and hydraulic lifters are used.

‡ This step is required for 1970-'72 engines if stock primary chain oiling is desired. However, 1973-'77 stock breather gear or S&S part #33-4253 will be needed, but is not included in kit #31-6203. Kit #31-6294 is recommended.

† This kit includes #33-4232 pinion shaft pump drive gear, designed to fit S&S 1958 and later style tapered pinion shaft or stock 1954-1989 tapered pinion shaft. Engines using 1990-later style straight pinion shaft must use stock pinion shaft oil pump drive gear.

**Chart 1**

**NOTES**

- Certain applications require crankcase modifications to be performed using Oil Pump Drillin Jig 53-0013. Numbers by drilling guide holes in drilling jig match step numbers in this instruction sheet.
- It is imperative that all metal chips, filings, dirt and other contaminants be removed prior to assembly. Use appropriate parts cleaner and blow out oil passages with compressed air.

**CAUTION**

**Metal filings, dirt and other foreign matter can cause extensive damage to oil pump and engine.**

**WARNING**

**Compressed air and particles dislodged by compressed air are potentially harmful. Wear protective goggles when using compressed air and always direct air stream away from yourself and others nearby.**

Some oil pump kits include optional parts such as drive shaft gear, pinion drive gear and/or breather gear kit. **See Chart 2.**

| Pump Kit Part No. | Pump Body Part No. | Pump Cover Part No. | Drive Shaft Drive Gear Part No. | Pinion Shaft Drive Gear Part No. | Breather Gear Kit Part No. |
|-------------------|--------------------|---------------------|---------------------------------|----------------------------------|----------------------------|
| 31-6200           | 31-6048            | 31-6059             | N/A                             | N/A                              |                            |
| 31-6203           | 31-6050            | 31-6059             | N/A                             | N/A                              | N/A                        |
| 31-6205           | 31-6051            | 31-6061             | N/A                             | N/A                              | N/A                        |
| 31-6206           | 31-6051            | 31-6062             | N/A                             | N/A                              | N/A                        |
| 31-6292           | 31-6048            | 31-6059             | 33-4230                         | 33-4237§                         | 33-4253                    |
| 31-6293           | 31-6048            | 31-6059             | 33-4230                         | 33-4232†                         | 33-4253                    |
| 31-6294           | 31-6050            | 31-6059             | 33-4230                         | 33-4232                          | 33-4253                    |
| 31-6295           | 31-6050            | 31-6059             | 33-4230‡                        | 33-4232                          | 33-4250                    |
| 31-6296           | 31-6051            | 31-6062             | 33-4230‡                        | 33-4232                          | 33-4250                    |

§ Pinion shaft pump drive gear, part #33-4237 for 1939-1953 engines, is easily distinguished from 1954-later gears by inside diameter splines machined to fit early style splined pinion shafts

‡ Breather valve gear kit, part #33-4250 for 1977-'99 engines, has different pitch diameter than 1977-earlier gears and can be identified by circular channel machined in gear face.

† #33-4232 pinion shaft pump drive gear fits S&S tapered pinion shaft for 1958-later and stock 1954-1989 style tapered pinion shaft. Gear #33-4232 is 6-tooth and requires 24-tooth oil pump driveshaft gear. Resulting 4:1 ratio is same as stock 1973-up. Engines using stock 1990-'99 style straight pinion shaft must use stock pinion shaft pump drive gear.

**Chart 2**

**Oil Pump Body Identification**

Oil pump bodies for different kits feature important differences in internal machining. Before beginning installation, refer to Chart 2 and confirm that you have the correct oil pump body. Note the part number machined on the body, and compare pump body you received with those in photos to for identification. **See Pictures 1, 2, and 3.** Pump bodies are designed for specific year groups and must not be interchanged or installed on engines other than those they were designed for.

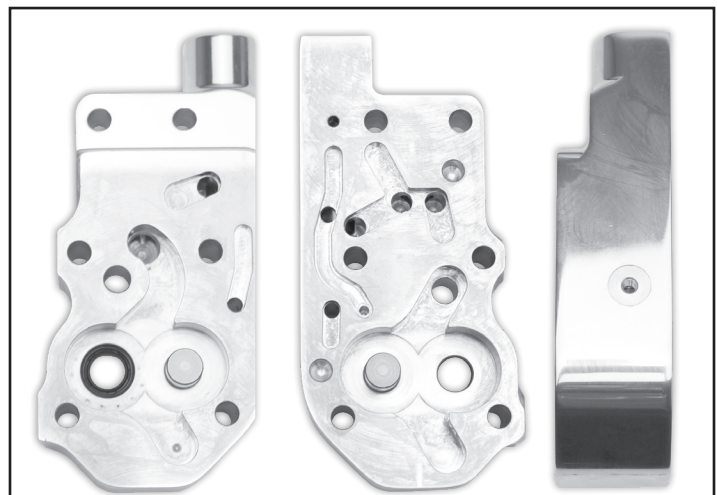

**Picture 1**  
32-6048 - 1936-'72



**Picture 2**  
31-6050 - 1970-'91



**Picture 3**  
31-6051 - 1992-'99

Oil pump bodies and covers for 1992-up engines have slightly different mounting bolt patterns than covers for earlier engines. **See Picture 5.**

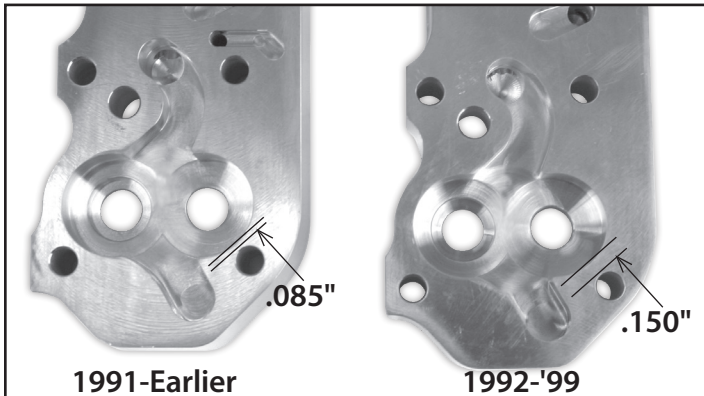

**Picture 4**

*NOTE: S&S has used 1991-earlier and 1992-later style oil pump mounting bolt pattern in S&S engines. Confirm pattern prior to ordering replacement pump body or cover. See Picture 4. Oil pump gasket of known year can be used to positively identify mounting bolt pattern.*

### Oil Pump Cover Identification

S&S® manufactures three different oil pump covers for S&S oil pumps. **See Pictures 5, 6, and 7.** Universal covers are machined with a number of oil holes that allow the pump to be connected to oil lines in various ways for maximum installation flexibility. Custom covers only have lower holes for feed and return lines, and offer a cleaner custom look. Both Universal covers and Custom covers are available machined with mounting bolt patterns for 1936-'91 and for 1999-'99 engines.

### Oil Hole Identification

1. Top oil return hole
2. Top oil supply hole
3. Oil pressure switch or gauge hole
4. Lower oil supply hole
5. Lower oil return hole
6. Middle oil supply hole
7. Front chain oiler hole

1. Cover #31-6059 has 1991 and earlier mounting bolt pattern. Cover #31-6059 allows builder to choose top or bottom location for oil line fittings and has provision for primary chain oiler and oil pressure sending unit if desired.



**Picture 5**  
31-6059 - 1936-'91 Universal

2. Covers #31-6061, and #31-6062, have 1992-'99 mounting bolt pattern. "Universal" cover #31-6061 allows builder to choose top or bottom location for oil line fittings and has additional provision for supply line fitting in face of cover. Cover #31-6062 has no provision for top-mounted oil line fittings but otherwise is similar to cover #31-6061.

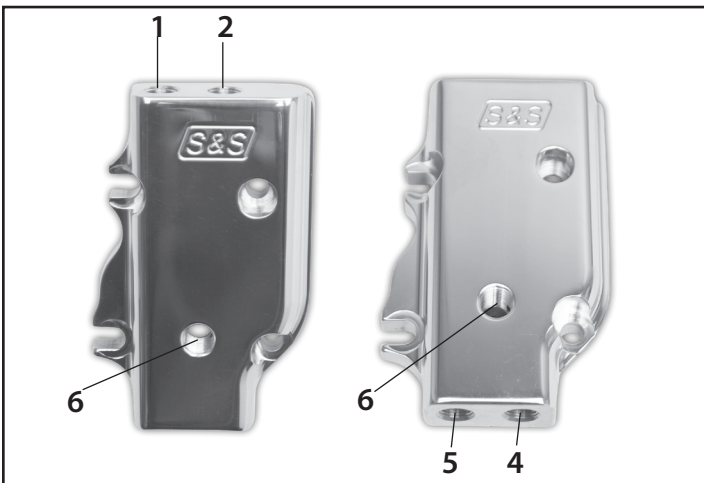

**Picture 6**  
**31-6061 1992-'99 Universal**

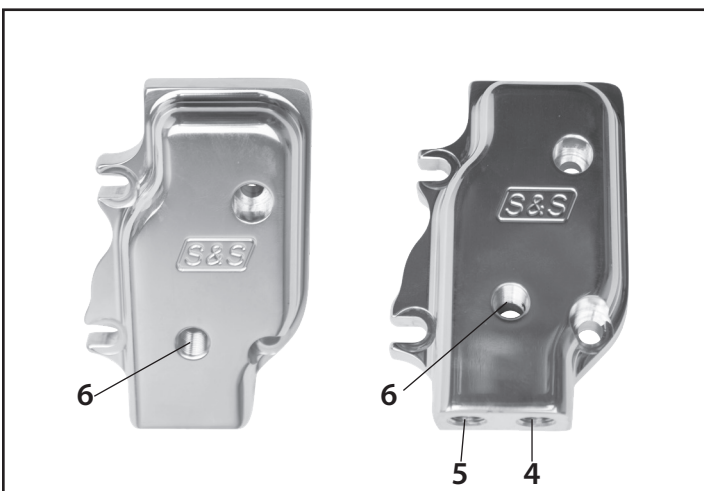

**Picture 7**  
**31-6062 1992-'99 Custom**

**CAUTION**

**Bottom-mount oil supply line fitting is not recommended for models with oil tank below transmission because of possibility of cavitation or "air lock" occurring during oil changes. See Appedix on Page 16 for information on preventing cavitation.**

**Notes**

- Use only S&S oil pump gaskets. S&S gaskets are not interchangeable with stock gaskets.
- Increased wall thickness of some aftermarket crankcases may interfere with proper installation of oil pump. Procedure for insuring correct fit is described in Installation Step 1.
- All standard S&S oil pumps provide same oil volume and pressure as 1973 -1999 Harley-Davidson® pumps if stock drive gears are used. S&S oil pump supplies 33% more volume than cast iron pumps used on 1936-1967 big twins. An additional 25% increase can be achieved on engines manufactured between 1939 and 1972 if optional S&S pinion and oil

*pump drive-shaft gears with 4:1 ratio are installed with S&S pump. (Stock pre-1973 ratio is 5:1.)*

- S&S recommends optional pinion and oil pump drive shaft gears for most engines because increased oil supply is usually beneficial. However, marginal oil scavenging from top end may cause problems if later style drive gears are used in a knucklehead. Even with standard drive gears, knucklehead engines with S&S pump may require restriction of top end oil supply. Oil fitting for top end supply line can be filled with solder and metering hole drilled in solder to restrict oil flow. S&S has performed tests and has successfully operated engines including panhead and shovelhead with metering holes as small as .060".
- Chrome Plating - S&S does not recommend chrome plating oil pump body or cover. Proper preparation for plating requires abrasive buffing compounds which can plug critical passages and otherwise damage oil pump. Also, it is extremely difficult to chrome plate oil pump without altering critical machined surfaces. Chrome in these areas can impair pump's performance by altering critical operating tolerances. In addition, chrome may flake off and cause damage to pump and engine.
- Powder coating - Subjecting heat-treated alloys such as those used in S&S oil pumps, crankcases, cylinders and heads to excessive heat can drastically alter hardness, strength and other important properties. Degree to which these properties are altered depends upon temperatures reached and duration of exposure. When Powder coating or otherwise processing alloy parts, S&S exposes them to a maximum temperature of 370° F for no longer than 20 minutes. Under no circumstances should parts be heated past 400° F. Owner assumes all risk and liability for altering oil pump except to insure correct fit.

**CAUTION**

**Plating or otherwise altering S&S oil pump or any component thereof may cause irreversible damage to pump and interfere with engine lubrication. Damages caused by altered oil pump or component will not be covered under warranty.**

**Installation Steps**

**1. Disassembly and Crankcase Identification - All Years.**

- a. Remove old oil pump, gear cover, camshaft, drive gears, and oil pump mounting studs (if applicable) from crankcase.
- b. Identify crankcases by comparing them to crankcases in **Picture 8**. Circle year group that matches your crankcases to avoid confusion later.

*NOTE: Proper identification of crankcase is imperative to insure correct pump installation. Machining of some aftermarket crankcases may not be consistent with a specific year group. If in doubt about modifications required for aftermarket crankcase, contact crankcase manufacturer.*

**CAUTION**

**Improper oil pump installation due to incorrect identification of crankcase year group may result in engine damage.**

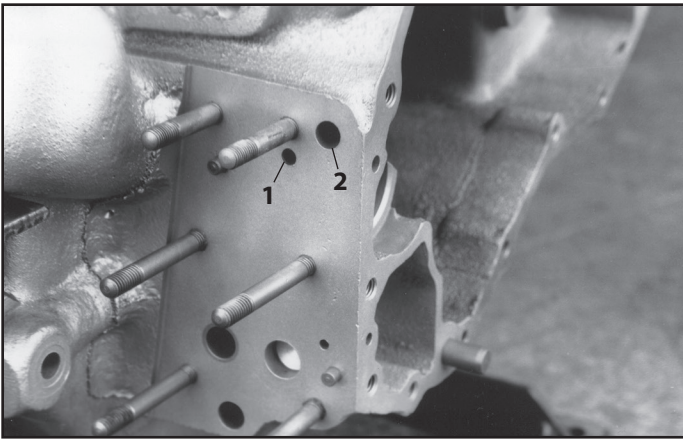

1936-1947

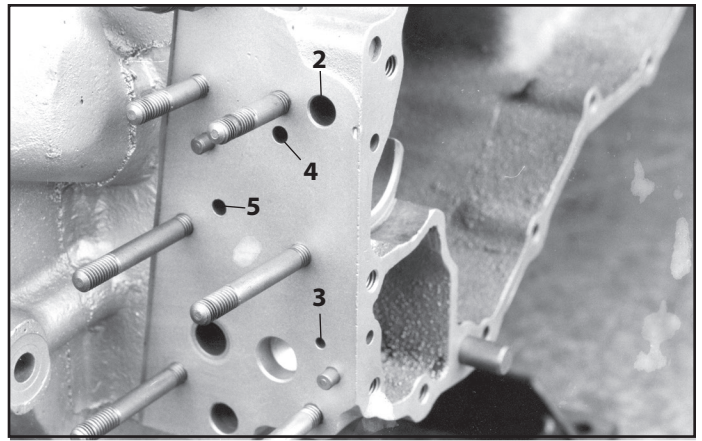

1948-1952

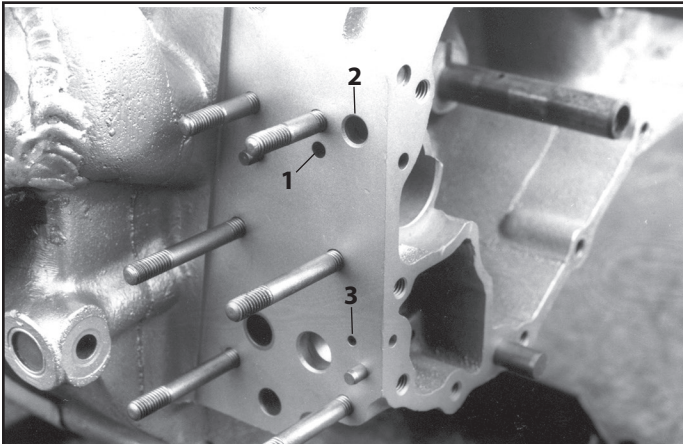

1953-1964

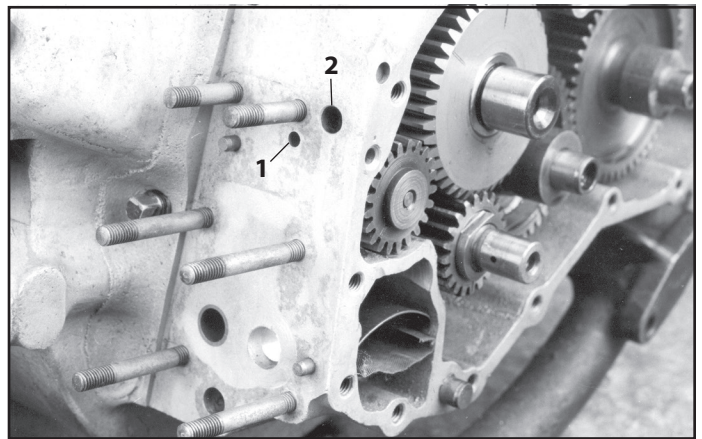

1965-1969

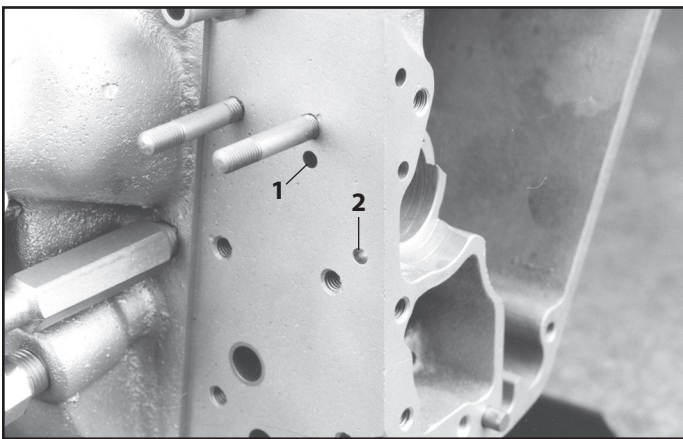

1970-1972

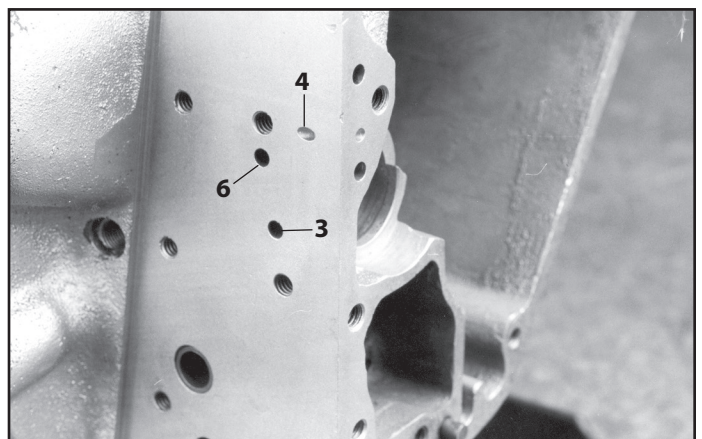

1973-1980

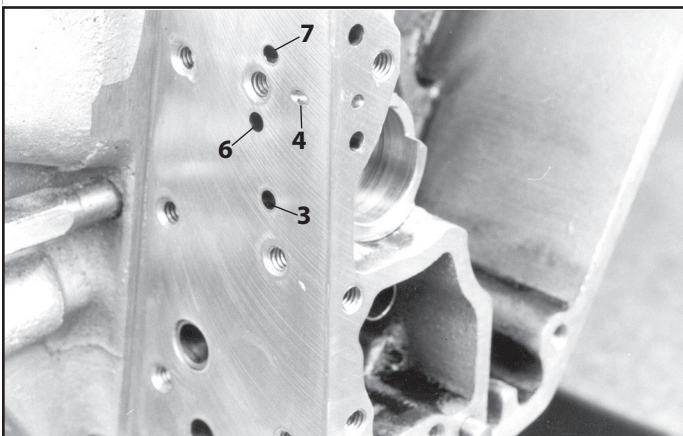

1981-1999

1. Main oil supply.
2. Excess oil and pressure valve relief.
3. Front chain oil.
4. Pinion shaft oil.
5. Top end oil.
6. Top end and tappet block oil.
7. Pressure valve relief.

- c. Confirm that adequate clearance exists between oil pump body and crankcase by temporarily installing pump assembly on crankcase and inspecting areas indicated in photo. **See Picture 9.** In some instances it may be necessary to file small amount of material from pump body to obtain correct fit. **See Picture 10.**

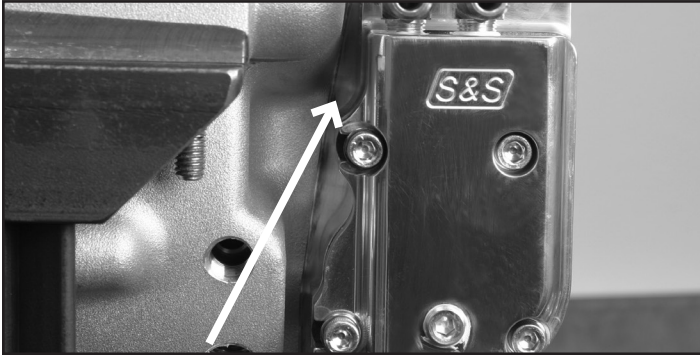

Picture 9

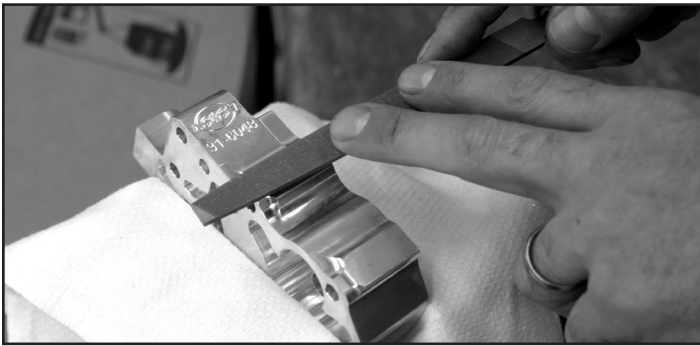

Picture 10

*NOTE: If modification of pump body is necessary, remove minimum amount of material required to properly position oil pump on crankcase. Take special care not to damage gasket surfaces. After modification, clean pump body thoroughly with suitable parts cleaner and compressed air to remove metal filings generated during procedure.*



**Failure to confirm fit of pump on crankcase as described in Step 1-c may result in oil pump damage not covered under warranty.**

**2. Crankcase Modification - 1970-1972 Crankcases Only Plug Stock 3/16" Oil Overflow Hole.**

This modification is required because the S&S oil pumps do not discharge excess overflow oil back into the crankcase, but instead recirculate it to the input of the pump.

- a. If engine has been removed from chassis, CAREFULLY enlarge hole in photo (**See Picture 11**) with .203" (13/64") drill. If engine has not been disassembled, apply grease to bit and both ends of hole to catch chips. Wrap masking tape around drill .225" from point to use as depth guide. If engine is in chassis, enlarging hole may be difficult. In this case hole may be tapped without enlarging, but extreme caution is required to avoid breaking tap off in hole.

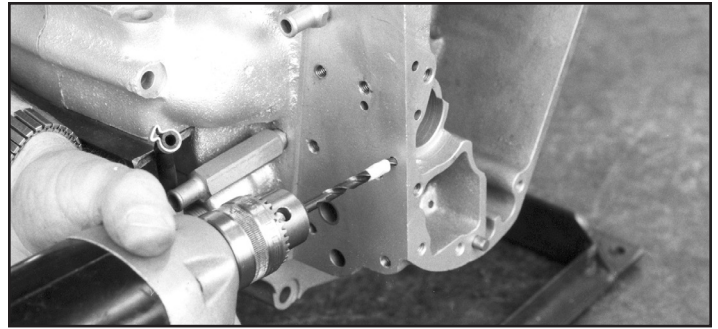

Picture 11



**Drill bit o.d. is close to hole size and may distort hole if drill is not steadied. Distorted hole may cause poor thread fit after hole is tapped.**

- b. Using 1/4 -20 tap, carefully tap hole deep enough for 1/4 -20 set screw provided in kit to rest flush with or slightly below gasket surface. **See Picture 12.** If necessary, reapply grease to both sides of hole before inserting tap. Use straight edge to confirm set screw does not protrude above gasket surface. **See Picture 13.**

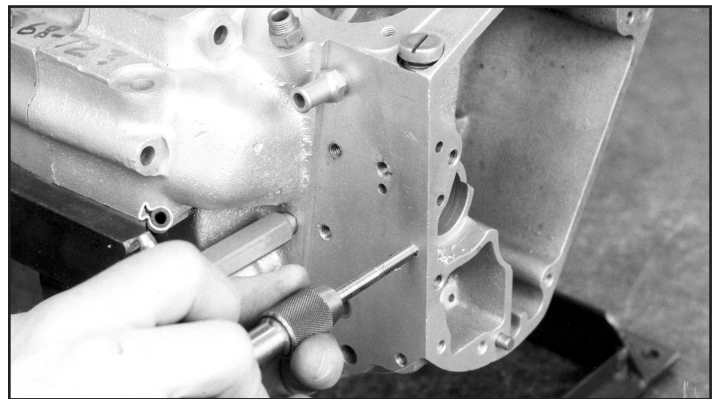

Picture 12

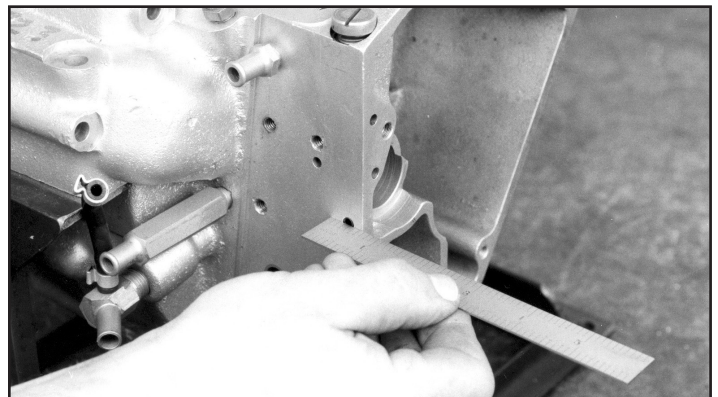

Picture 13

**NOTE: Do not tap hole deeply enough for screw to be threaded completely through hole. Goal is to have screw tighten just as it becomes flush with or slightly below oil pump gasket surface.**

- c. Apply Loctite® to threads and install 1/4-20 set screw.

### 3. Crankcase Modification - 1970-1980 Only. Drill Pressure Valve Relief Hole.

This modification is required for 1970-'80 crankcases to update them to 1981-'99 style Pressure Valve Relief system used in S&S oil pumps.

- a. Install S&S® Oil Pump Drill Jig, part #53-0013, or Harley-Davidson® Crankcase Oil Passage Drilling Jig, part #94461-81 or #94461-82, on oil pump gasket surface of crankcase.
- b. Use .125" (1/8") drill bit to drill pressure relief hole into gear cavity. **See Picture 14.** Apply grease to bit and both sides of case. Withdraw drill frequently during procedure to clear chips.

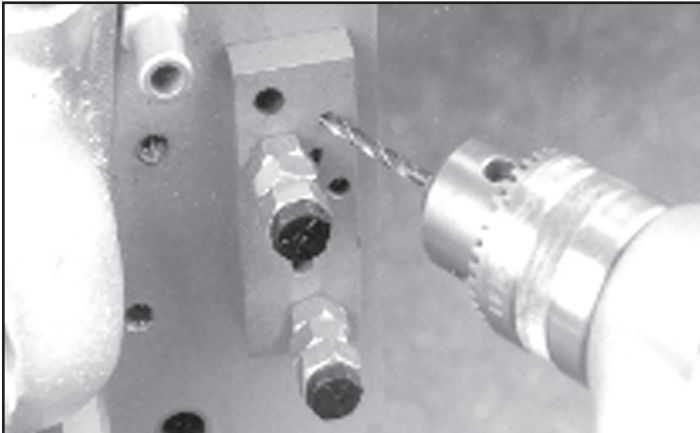

Picture 14

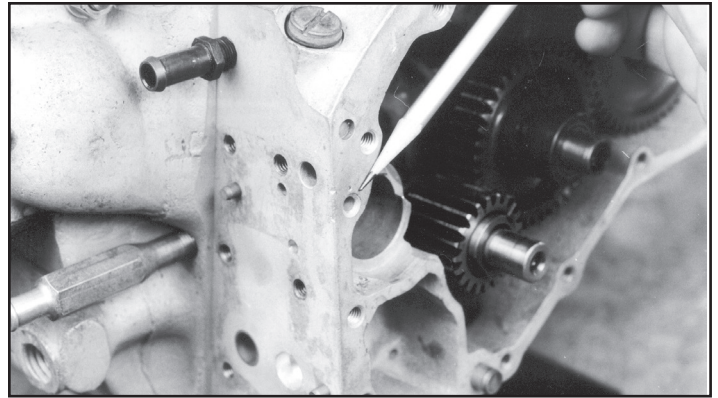

Picture 15

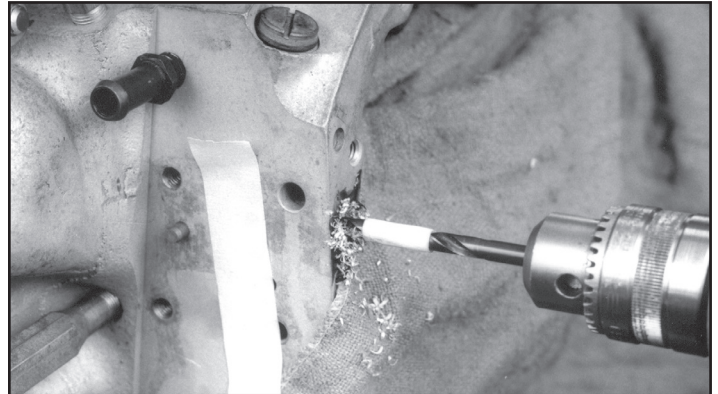

Picture 16

**CAUTION**

**Do not perform Step 3 on stock 1936-1969 crankcases or any other crankcase with angled tappet screen passage. Drilled passage will intersect tappet screen oil passage resulting in loss of oil pressure and serious engine damage.**

### 4. Optional Crankcase Modification - 1948-1962 using 31-6048 Body Plug and Redrill Crankshaft Feed Hole.

This modification is recommended only if engine has been modified to run an oiling pinion shaft. Object of modification is to alter 1948-1962 crankcases to 1973-later style oiling. With this system, heads and lifters get primary, unrestricted oil feed supply. Main and rod bearings in lower end get secondary, lower pressure oil after top end is supplied. This procedure should not be performed on 1963-1965 panhead engines with outside top end oil lines.

**CAUTION**

**If performed on 1963-'65 panhead engines with outside top end oil lines, modification described in Step 4 will cause oil starvation to top end and extensive engine damage.**

*NOTE: S&S® crankcases for 1948-1969 engines are already drilled and tapped, so installation of plug as described in Step d is only step required to complete modification.*

- a. Wrap masking tape around .203" (13/64") drill bit .850" from point to use as depth guide. Carefully drill hole shown in **Picture 15** to .850" deep. **See Picture 16.**

*NOTE: Drill size is very close to hole size and may distort hole if drill is not steadied.*

**CAUTION**

**Distorted hole may cause poor thread fit after hole is tapped.**

- b. Using 1/4-20 tap, carefully thread hole deeply enough for 1/4 -20 set screw provided in kit to bottom out with screw head .540" to .600" below gear cover gasket surface. **See Picture 17.**

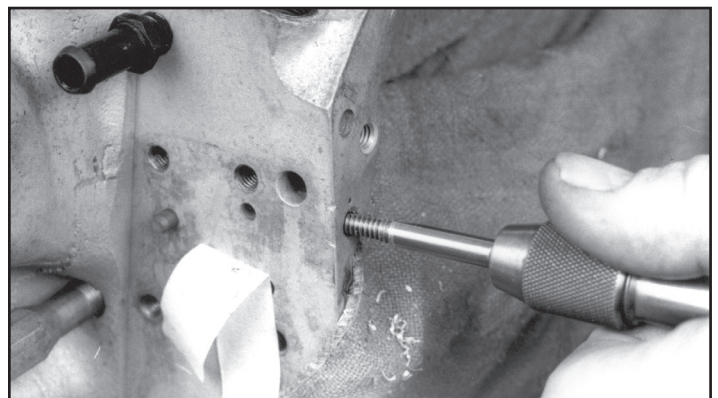

Picture 17

- c. Remove tap periodically, clear chips, and install set screw to check depth. **See Picture 18.**

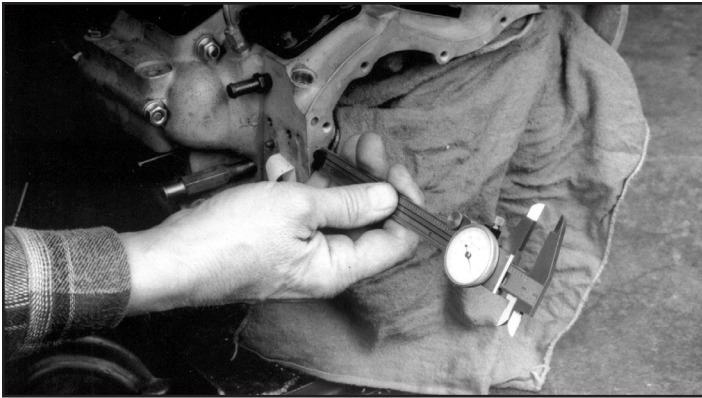

Picture 18

**NOTE:** Do not tap hole deeply enough for set screw to block tappet screen oil feed passage. This will restrict oil supply to lifters and cylinder heads.



**Restricted oil supply may cause extensive engine damage.**

- d. On 1948-1952 crankcases, blow air into intersecting hole in pump gasket surface to remove chips. On 1953-1969 crankcases, remove oil plug and lifter screen filter assembly and blow air into passage to remove chips. **See Picture 19.**

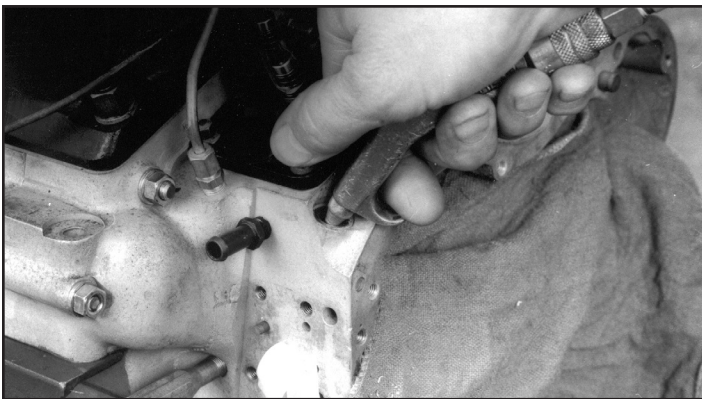

Picture 19

**NOTE:** Before attempting to remove chips, remove set screw to allow chips to escape.



**Compressed air and particles dislodged by compressed air are potentially harmful. Wear protective goggles when using compressed air and direct air stream away from yourself and others nearby.**

- e. Apply Loctite® to threads of ¼ -20 set screw provided and install screw to depth of .540" to .600" below gear cover gasket surface.
- f. Install S&S® Oil Pump Drill Jig, part #53-0013, on crankcase oil pump gasket surface. **See Picture 20.**
- g. Wrap masking tape around .1875" (3/16") drill bit .750" (3/4") from drill point. Using tape as depth guide, drill hole into pump gasket surface .375" (3/8") deep, until it breaks into passageway just tapped. (Hole to be drilled is 3/8" deep and drill jig is 3/8" thick; 3/8" + 3/8" = 3/4"). **See Picture 20.**

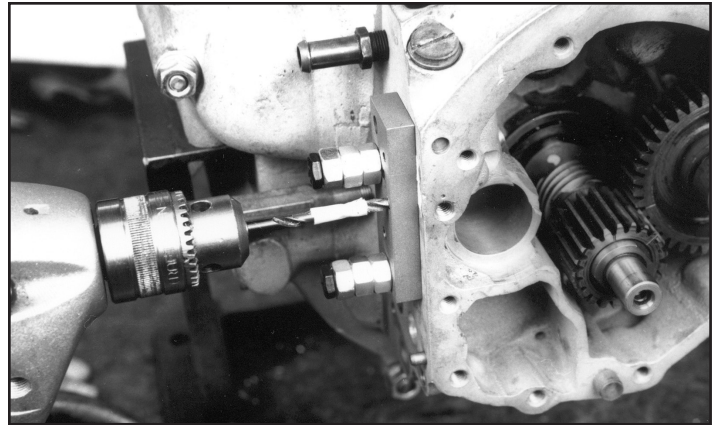

Picture 20

**NOTE:** Do not drill hole too deep. Hole must not extend into gear cavity side of crankcase.



**Improperly drilled oil feed hole may cause oil to bleed off into gear cavity resulting in oil pressure loss and possible engine damage.**

- h. Remove drill jig and blow air into passage to remove chips. **See Picture 21.**

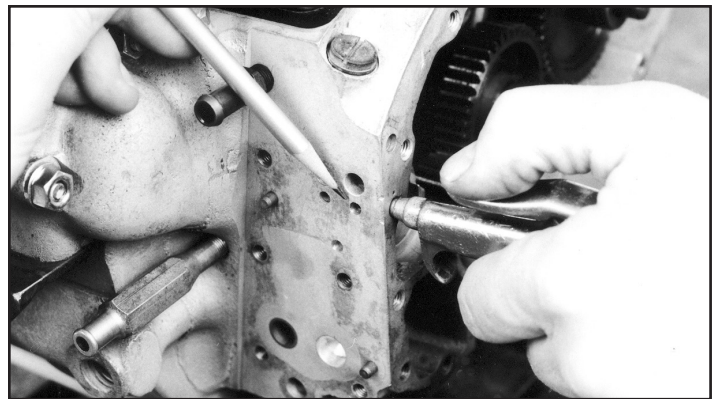

Picture 21



**Metal filings, dirt and other foreign matter can cause extensive damage to oil pump and engine.**



**Compressed air and particles dislodged by compressed air are potentially harmful. Wear protective goggles when using compressed air and direct air stream away from yourself and others nearby.**

**5. Optional Crankcase Modification - 1970-1972 only, using #31-6050 pump body- Plug and Redrill Crankshaft Feed Hole**

Object of modification is to alter 1970-1972 crankcases to 1973-1999 style oiling, for engines converted to 1973-'81 style oiling with an end oiling pinion shaft. With this system the heads and lifters get primary, unrestricted oil feed supply. Rod bearings in lower end get secondary, low pressure oil via the pressure relief plunger after the top end is supplied. **If engine has been updated to an end oiling pinion shaft, either Step 5a or 5b MUST be done depending on the cam cover used.**



**CAUTION**

Failure to isolate the pinion shaft oiling circuit from the top end oiling circuit as is done on 1973-1999 OEM engines, and providing top end oil directly to an end oiling pinion shaft will result in zero oil pressure at idle in a fully warmed up engine.

- a. Plug and Re-drill: Using a Modified 1970-1972 Stock Style Cam Cover
- i. Wrap masking tape around .203" (3/16") drill bit .375" (3/8") from drill point. Carefully enlarge hole in **Picture 22**. Using tape as depth guide, drill hole .375" (3/8") deep. **See Picture 23**.

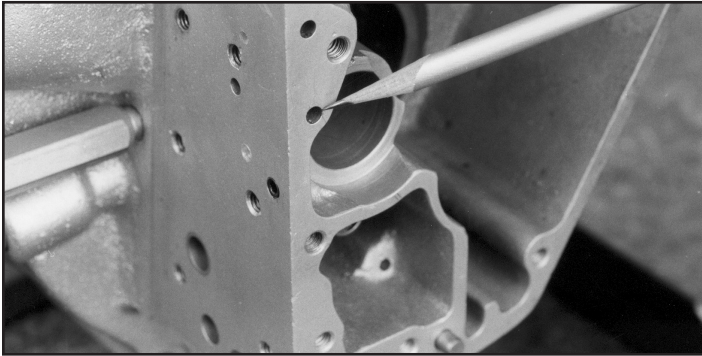

**Picture 22**

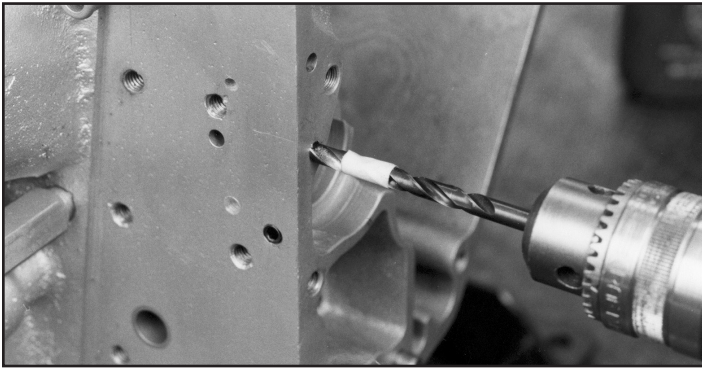

**Picture 23**

**NOTE:** Drill bit size is very close to hole size and may distort hole if drill is not steadied.

**CAUTION**

**Distorted hole may cause poor thread fit after hole is tapped.**

- ii. Using 1/4 -20 tap, Carefully tap hole deep enough for 1/4-20 allen head set screw supplied in kit to bottom out with screw head .125" to .150" below gear cover gasket surface. **See Picture 24**.

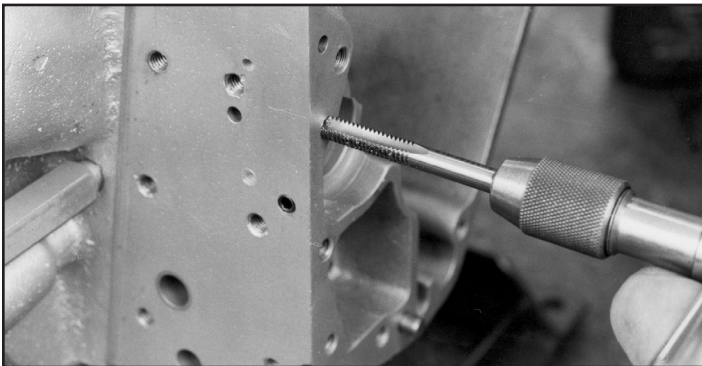

**Picture 24**

- iii. Remove tap periodically, clear chips, and install set screw to check depth. **See Picture 25**.

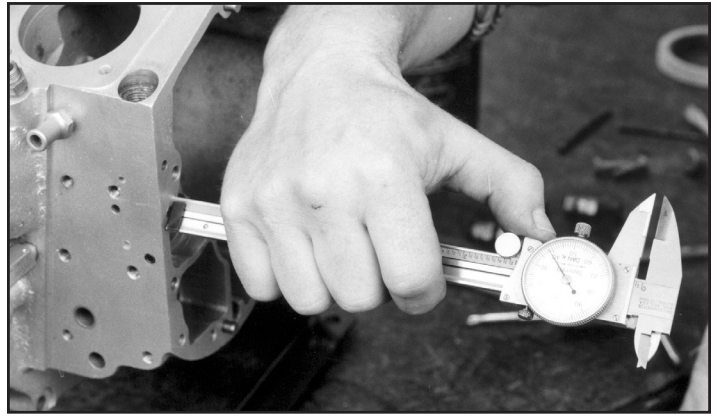

**Picture 25**

**NOTE:** Do not tap hole so deep that screw blocks tappet screen oil feed passage, inadvertently restricting oil supply to lifters and cylinder heads.

**CAUTION**

**Restricted oil supply may cause extensive engine damage.**

- iv. Remove oil plug and lifter screen filter assembly. Blow air in top end supply hole directly below top right pump mounting bolt hole to remove chips and ensure that passage is not blocked. **See Picture 26**.

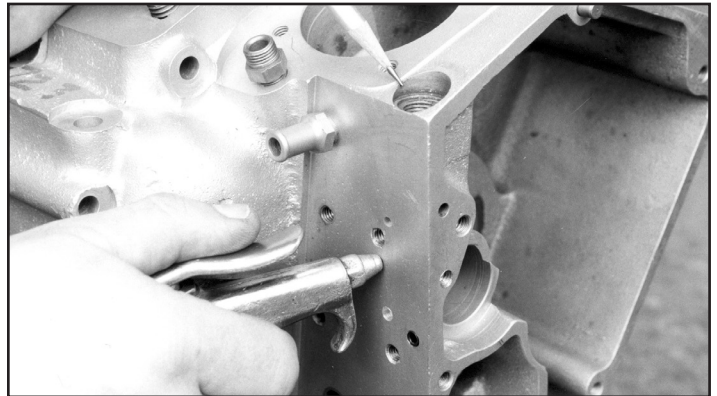

**Picture 26**

**WARNING**

**Compressed air and particles dislodged by compressed air are potentially harmful. Wear protective goggles when using compressed air and direct air stream away from yourself and others nearby.**

- v. Remove 1/4 -20 set screw, apply Loctite® to threads and install screw to depth of .125" to .150" below gear cover gasket surface.
- vi. Install S&S® Oil Pump Drill Jig part #53-0013 on gear cover gasket surface. **See Picture 27**. Using a .125" (1/8") bit, drill angled hole from passage just plugged until it breaks through pump gasket surface. **See Picture 28**. While drilling hole, withdraw drill frequently to clear chips.

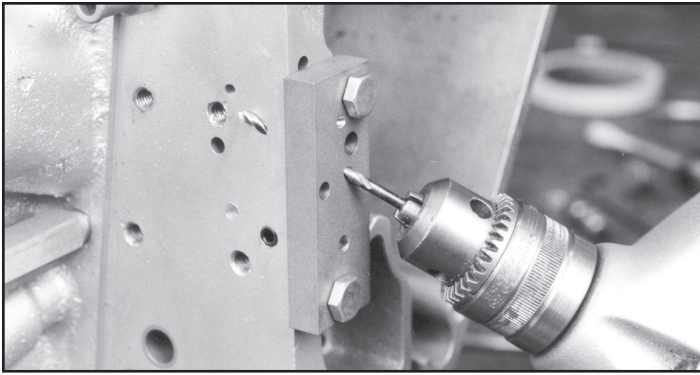

Picture 27

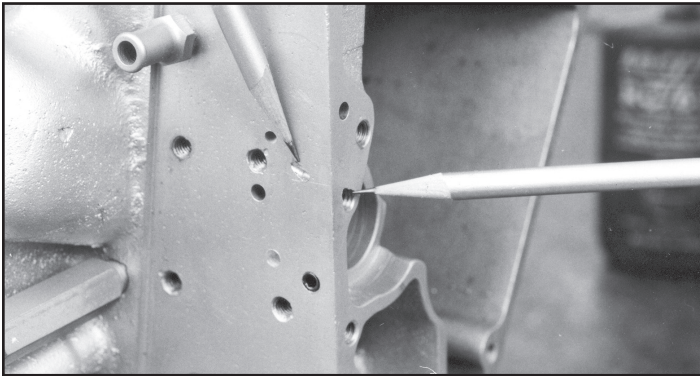

Picture 28

- vii. Remove drill jig and blow compressed air into passage to remove chips. Note previous cautions regarding compressed air.
- viii. Change pinion bushing in cam cover to the H-D® part number 25582-73 using the procedure outlined in the H-D® factory service manual.
- ix. Plug cam cover pinion bushing vent hole using the appropriate size set screw and Loctite® Sleeve Retainer 640
- b. Drill: Using a 1973-1992 Stock Style Cam Cover
  - i. Install S&S® Oil Pump Drill Jig part #53-0013 on gear cover gasket surface. See **Picture 29**.

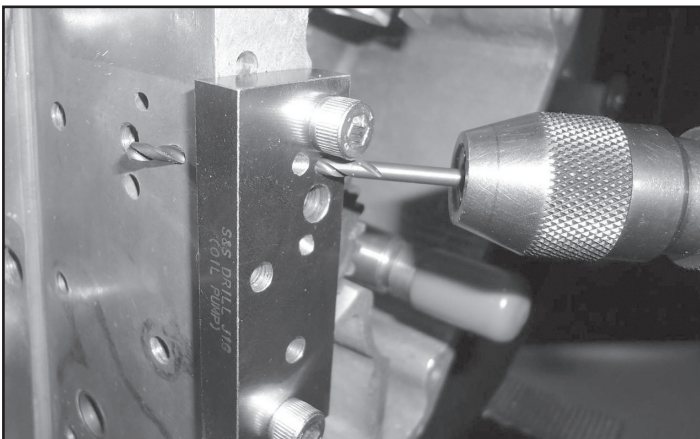

Picture 29

- ii. Using a .125" (1/8") bit, drill angled hole until it breaks through pump gasket surface. While drilling hole, withdraw drill frequently to clear chips.
- iii. Remove drill jig and blow compressed air into passage to remove chips. Note previous compressed air cautions.

## 6. Crankcase Modification - 1970-1972 with kits using #31-6050 body - Drill Primary Chain Oil Supply Hole.

The object of this modification is to update early engines to meter primary chain oil automatically through breather gear rather than manually through external screw in pump body. Update requires use of 1973-later style breather gear such as S&S #33-4241. Gear is not included in kits, but may be purchased separately.

- a. Install S&S® Oil Pump Drill Jig, part #53-0013, on oil pump gasket surface as shown in **Picture 29**.

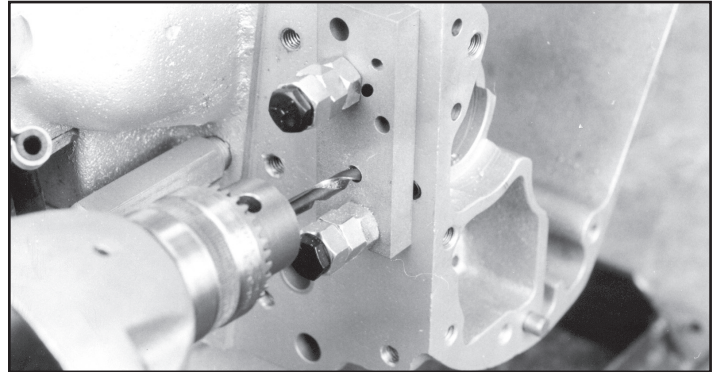

Picture 29

- b. Using .1875" (3/16") drill bit CAREFULLY drill hole into pump gasket surface until bit breaks out in breather valve gear cavity. See **Picture 30**. If modification is done while engine is still assembled, apply grease to both sides of case to help catch chips.

**NOTE:** Drill hole slowly and carefully to avoid contacting opposite wall of cavity when drill breaks through.



**Contacting breather cavity wall with drill may damage machined surface and make crankcase unusable.**

- c. Remove drill jig and clear chips away.
- d. Carefully debur hole in breather valve gear cavity.

## 7. Oil Pump Cover Assembly - All Years

S&S® manufactures three covers for current S&S oil pumps. Cover #31-6059 has 1991-earlier mounting bolt pattern. Covers #31-6061, and #31-6062, have 1992-later mounting bolt pattern.

- a. Identify cover and insure that cover is correct for application. **Refer to Chart 1 on Page 2 and see Pictures 5, 6, and 7 on Pages 3 and 4 .**
- b. Installer must decide which oil line fittings and other required hardware will be used. Correct identification of locations for supply, return, and other pump cover fittings is critical. **See Pictures 5, 6, and 7 on page 3 and 4**
- c. All covers require fittings for supply and return lines. Some covers offer more than one location for supply and/or return line fittings. Only one supply and one return fitting will be used. Block off holes not used with supplied pipe plugs.
- d. Some covers provide for primary chain oiler and/or oil pressure sending unit in addition to supply and return fittings.



**Incorrect placement of oil lines or oil line fittings can cause extensive engine damage not covered under warranty. See Appendix (Page 16) for correct routing of oil pump lines.**

## NOTES

- Oil pump overs #31-6061 and #31-6062 for 1992-'99 are compatible with rigid oil return and supply lines found on 1992-up rubber-mount models. In these applications, hole #6 in face of cover is used for supply line, hole in bottom left location is used for return line. After installing elbow fitting #50-1007 for return line, customer must install compression fitting #50-8120 (supplied in kit) in elbow rather than conventional hose fitting #50-8115. Fitting #50-8115 will be used for supply line fitting. For use with OEM rigid oil lines, return fitting must face forward, toward front of engine. Supply fitting will face downward at approximate 45° angle toward lower left corner of pump cover.
- Universal covers #31-6059 (early bolt pattern) and #31-6061 (late bolt pattern) appear similar, and both are compatible with rigid oil return line found on 1992-up rubber-mount models. HOWEVER, holes in face of covers have different functions. Hole #3 in face of cover #31-6059 is high-pressure site intended for oil pressure sending unit. Hole #6 in face of cover #31-6062 is intended for oil supply line from tank. Oil Pump overs #31-6059 and #31-6061 are not interchangeable. **See Pictures 5 and 6 on Pages 3 and 4**
- S&S® does not recommend using hole #3 in cover 31-6059 for a top end oil supply because oil from hole #3 bypasses hydraulic lifter filter screen. Builder assumes responsibility for any damages caused by using hole #3 for top end oil supply.



- **Always apply PTFE plumber's tape or pipe sealant such as Slic-tite to threads of fittings before assembling fittings or installing fittings in cover. Failure to install fittings correctly may damage cover and void warranty.**
- **Apply tape and pipe sealant to threads only. Avoid using excessive amounts that may protrude into and obstruct oil passages or contaminate engine oil. Incorrect use of PTFE tape or pipe sealant may cause engine damage not covered under warranty.**
- e. Cover #31-6059 - **See Picture 5, page 3.** Fittings for oil supply and return lines can be placed in holes at either bottom or top of cover according to installer's requirements. Hole #3 in face of cover is intended for oil pressure sending unit. This hole cannot be used for supply or return line! Cover #31-6059 also has provision for primary chain oiler.
  - i. Preparation - Apply PTFE tape or pipe sealant to threads of 2 ea. 90° elbow fittings #50-1007, 2 ea. hose fittings #50-8115, and 2 or 3 ea. 1/8"-27 pipe plugs #50-8331, depending on whether oil pressure sending unit/gauge will be used in hole #3. If 1992-up rigid return line is used, substitute compression fitting #50-8120 for 1 hose fitting #50-8115. If primary chain oiler is used, apply tape or sealant to 1/16"-27 hose fitting #50-8116. If primary chain oiler is not used, apply tape or sealant to 1/16"-27 pipe plug #50-8332.
  - ii. Install elbow fittings in locations #1 or #5 (return) and #2 or #4 (supply). Hole #5 must be used for 1992-up rigid return line. If applicable, apply PTFE tape or pipe sealant to threads and install oil pressure gauge/sending unit (not supplied) in hole #3. Install 1/8"-27 pipe plugs in holes not used.
  - iii. If primary chain oiler typically found in 1965-1984 models is used, install 1/16"-27 hose fitting in hole #7. If primary chain oiler is not used (belt primary drive or sealed primary housing), install 1/16"-27 pipe plug in hole #8.

- iv. Install hose fittings in elbows. Substitute compression fitting #50-8120 for hose fitting in hole #5 if 1992-up rigid return line is used. Compression fitting must face forward for use with rigid return line.

## NOTES:

- 1992-up rigid supply line will require modification for use with cover #31-6059.
- Return fitting in hole #5 will normally be directed toward oil filter. For instance, return fitting will normally face forward in models with oil filter in front of crankcase.

- f. Cover #31-6061 - **See Picture 6, Page 4.** Cover #31-6061 is often referred to as S&S® universal cover. It is supplied on S&S engines unless customer specifies otherwise at time of order. Universal cover is compatible with rigid supply and return lines used on 1992-up rubber mount models. Fittings for oil supply and return lines can be placed in holes at either bottom or top of cover as required by purchaser. Fitting for main oil supply line can also be installed in hole in face of cover.

**NOTE:** Hole #6 in face of cover #31-6061 can be used as main oil supply line only. This hole is on the input side of the pump and can not be used for oil pressure monitoring.

- i. Preparation - Apply PTFE tape or pipe sealant to threads of 2 ea. 90° elbow fittings #50-1007 and 2 ea. hose fittings #50-8115. Substitute compression fitting #50-8120 for one hose fitting #50-8115 if 1992-up rigid return line is used.
- ii. Install elbow fittings in holes #1 or #5 (return), and #2 or #4, or #6 (supply). Hole #5 will be used for 1992-up rigid return line. Hole #6 will be used for 1992-up rigid supply line.
- iii. Install hose fittings #50-8115 in elbows. If compression fitting #50-8120 is used for 1992-up rigid return line, install in hole #5 elbow.

**NOTE:** If rigid oil lines are used, return fitting must face forward, toward front of engine. Supply fitting will face downward at approximate 45° angle toward lower left corner of pump cover.

- g. Cover #31-6062 - **See Picture 7, Page 4.** Fitting for main oil supply line fitting can be placed in hole #6 in bottom of cover or hole in face of cover. Bottom hole is only location for return line fitting. Cover #31-6062 is compatible with 1992-up rigid return line.

**NOTE:** Hole #6 in face of cover #31-6062 can be used as main oil supply line only. This hole is on the input side of the pump and can not be used for oil pressure monitoring..

- i. Preparation - Apply PTFE tape or pipe sealant to threads of 2 ea. 90° elbow fittings #50-1007, 2 ea. hose fittings #50-8115, and one 1/8"-27 pipe plug #50-8331. Substitute compression fitting #50-8120 for one hose fitting if 1992-up rigid return line is used.
- ii. Install elbow fittings in holes #5 (return), and #6 or #4,.
- iii. Install hose fittings #50-8115 in elbows. If compression fitting #50-8120 is used for 1992-up rigid return line, install in elbow in hole #5.

## 8. Oil Pump Installation

### NOTES:

- S&S includes both ¼ -20 and ¼ -24 mounting bolts in oil pump kits. Visually compare threads and gently screw bolts into crankcase to confirm correct thread.
- S&S oil pump bodies, covers and gaskets may appear similar to stock or other manufacturer's components but should not be interchanged due to possible differences that could impair oil pump function.



Using oil pump components other than those provided by S&S® may result in oil leak, insufficient oil pressure and possible engine damage.

- Disassemble, clean, and inspect oil pump, then reassemble pump dry, without lubrication. (Pump will be lubricated in final step.) Inspect gaskets for loose bits of material that could dislodge and block oil passages.
- Set up primary chain oil supply and make preliminary adjustment for 1936-1964 engines with primary chain drive and dry clutch.
  - Install ⅙ -27 pipe plug #50-8116 in hole #7 in top of cover.
  - Install #31-6026 adjuster screw, #50-7008 brass washer, and #50-5000 lock nut into threaded hole in side of pump body. Gently bottom screw three times to seat properly. See Picture 30.

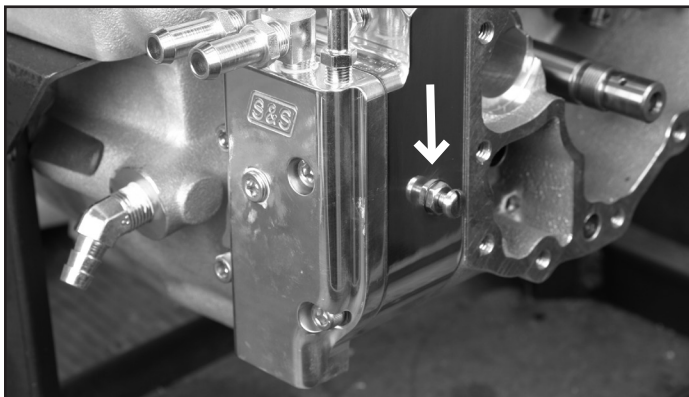

Picture 30



Chain oiler adjusting screw has tapered end and must be used. Substituting standard machine screw for tapered screw will result in large oil loss out breather. Oil may contact rear brake and tire, resulting in possible loss of control of motorcycle and injury to rider and others.

- Turn screw out ½ turn and tighten locknut against brass washer and body.

**NOTE** - After engine has been run, it may be necessary to readjust screw to achieve desired oil flow to primary chain. Final screw setting is generally slightly less than ½ turn



Overtightening screw may damage threads or adjusting screw seat in pump body.

- Set up primary chain oil supply and make preliminary adjustment for 1965-1972 engines with primary chain drive and dry clutch using, #31-6048 pump body. Must use pump cover 31-6059.

- Install #50-8116 hose fitting in threaded hole #7 on top of pump cover. This hose fitting will be connected to primary chain oil line.
- For 1965-1972 engines using #31-6048 pump body, install #31-6026 adjuster screw, brass washer #50-7008, and lock nut #50-5000 into threaded hole in side of pump body. See Picture 30. Gently bottom screw three times to seat screw.
- Turn screw out approximately 1¼ turns and tighten locknut against brass washer and oil pump body.

**NOTE:** Above setting should provide 1 to 1¼ oz: minute oil flow to primary chain @ 2500 RPM. This can be confirmed after engine has reached operating temperature by disconnecting hose to primary chain case, operating engine at 2500 RPM for one minute, and measuring oil delivered into container.

- Rotate gears as preliminary check for bind, and to confirm that drive gear keys are properly installed.

### NOTES

- Most S&S® oil pump gears have index marks. To assure proper gear mesh, marks must align when gears are installed in pump body. See Picture 31. Marks in photo have been darkened; they normally appear as light punch marks.

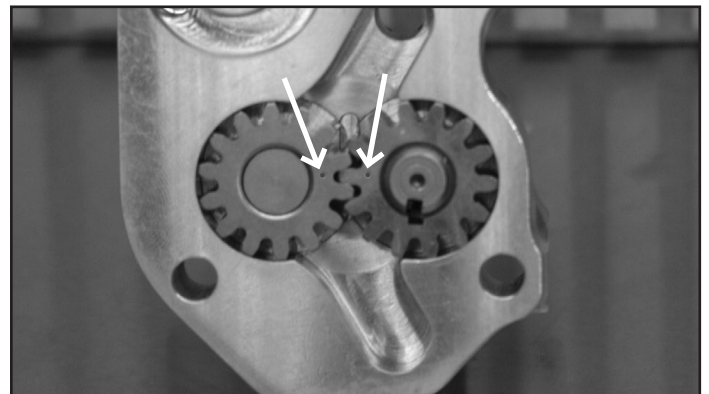

Picture 31

- If bind occurs, determine whether problem is with supply or return gears by removing idler gear from either side and rotating pump. When binding gear is removed, pump will rotate freely. Problem can usually be corrected by rotating gear 180°.



Failure to correct bind may result in damage to oil pump or other engine parts.

- Apply assembly lube or engine oil to oil pump driveshaft and driveshaft bushing in crankcase. Install oil pump in crankcase in normal fashion, placing pump drive gear #33-4230 over driveshaft as shaft is passed through bushing and into crankcase gear compartment. Refer to Harley-Davidson® service manual or contact professional mechanic if unsure about installation procedure.

**NOTE:** A dab of Hylomar® or other thin gasket sealer in corners of gasket may be used to hold gasket in place if care is taken to avoid critical areas such as oil passages and interior of oil pump. Otherwise, gaskets should be installed dry.

**CAUTION**

Gasket sealant may interfere with engine lubrication if allowed to enter oil pump or passages machined in crankcase. Damage related to improper use of gasket sealant will not be covered under warranty.

- f. Install driveshaft gear key and snap ring, taking care not to stretch or otherwise damage snap ring.

**NOTE:** Insure that drive shaft key and snap ring are installed properly. See **Picture 32**. If snap ring is installed incorrectly, sprung, or otherwise damaged, it may become dislodged or allow gear key to come out.

**CAUTION**

Loss of oil pump drive gear snap ring or key will result in disengagement of oil pump causing loss of oil pressure and possible engine damage.

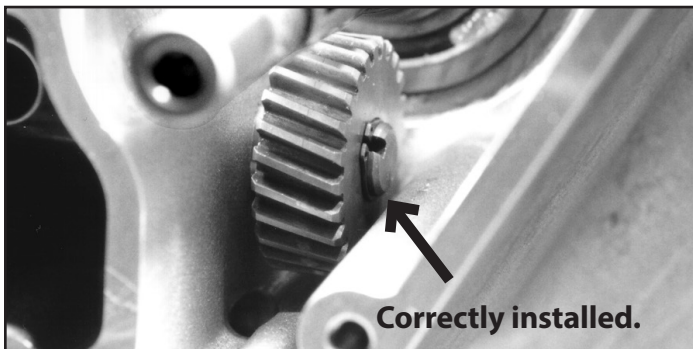

**Picture 32**

- g. Loosely install 2 ea. ¼ x 1½" bolts in upper holes in oil pump body, followed by pump cover and 4 ea. ¼ x 2¾" mounting bolts. Do not tighten at this time.

**NOTE:** ¼-24 bolts must be used on 1948-1978 Harley-Davidson® crankcases, ¼-20 bolts on later H-D® and S&S® crankcases. Check thread fit by carefully installing bolts in crankcase before installing pump. Thread engagement should be smooth and free of resistance.

**CAUTION**

Use of incorrect mounting bolts will damage crankcase damage not covered under warranty.

- h. While continually turning oil pump drive gear to check pump for binding, gradually tighten 2¾" bolts in X-pattern to final spec. of 90-120 in-lbs. If pump binds, loosen screws and shift pump slightly while rotating gears; pump should operate smoothly when correctly aligned on crankcase. Retighten bolts while turning driveshaft to confirm bind-free pump operation. Evenly tighten two remaining bolts to 90-120 in-lbs. If remaining bolts are inaccessible with torque wrench due to oil line fittings, temporarily remove fittings or carefully tighten bolts with thin box-end wrench.
- i. Prime pump by removing oil pump check ball valve and injecting clean motor oil into pump supply fitting while turning oil pump drive gear. (A large plastic squeeze bottle works well for this) Replace check ball, spring, and cap after oil fills check ball cavity.

**CAUTION**

"Air lock" or cavitation can occur if trapped air is not released from oil pump after installation. It can occur with new pump as well as used pump that has been removed from engine, and interferes with oil circulation. It is installer's responsibility to remove trapped air by priming pump prior to running engine and to confirm correct pump operation with engine running.

- j. Install pinion shaft oil pump drive gear, pinion gear, and remaining parts in gearcase following standard H-D® procedure. Note that pinion shaft oil pump drive gear has chamfer on one side. Place gear on pinion shaft with chamfer toward shoulder on shaft, facing center of engine.

**CAUTION**

Installing pinion shaft oil pump drive gear backwards on pinion shaft may cause stress riser resulting in eventual failure of shaft. Damage caused by incorrect installation of gear or other parts is not covered under warranty.

- k. Attach feed, return, and vent lines to oil pump. (See Appendix on Page 16)

### 9. Initial Startup and Post-operation Checks - All Years

- a. Fill oil tank filled to correct level, and start engine.
- b. Confirm oil circulation with oil pressure gauge and by removing cap from oil tank and observing oil return to tank. If oil is not seen returning to tank, S&S recommends removing return line from tank and placing end in drain pan to confirm oil circulation.

**NOTE:** Engine oil circulates under pressure. Areas exposed to escaping oil should be covered with rags and engine turned off immediately after oil circulation is confirmed to minimize oil loss.

**WARNING**

Oil on tires or brakes can cause loss of control of motorcycle resulting in serious injury to operator and others.

- c. After confirming oil circulation, run engine for several minutes and check for leaks.
- d. If applicable, confirm flow rate of primary chain oiler.

### NOTES:

- Low oil pressure is often blamed on oil pump when actual cause is worn bushings or another internal component. A new oil pump will not correct problems caused by worn parts. If low oil pressure exists after new oil pump is installed, check bearing clearances and other possible causes such as installation of different gear cover, tappet guides, etc.
- With engine hot, typical oil pressure reading is 3-4 PSI at 1000 RPM idle, 12-15 PSI at approximately 2500 RPM. If oil pressure reading is low, confirm with accurate mechanic's gauge. Oil pressure warning light comes on at approximately 3 PSI. Light may flicker at low RPM, but should quickly go out with slight increase in engine speed.
- Sudden clatter in previously quiet hydraulic lifter may indicate lifter failure OR excessively low oil pressure and should be investigated. It is not unusual for hydraulic lifters to clatter when a new or recently rebuilt engine is first started, but noise should disappear as lifters pump up.

## S&S® Oil Pump Replacement Parts

|                                                                  |           |                                                            |         |
|------------------------------------------------------------------|-----------|------------------------------------------------------------|---------|
| 1. Pump body assembly                                            |           | (each) .....                                               | 50-0088 |
| 1936-'72 .....                                                   | 31-6048   | 1/4"-20 x 1 1/2" - 1979-'99 (HHCS)                         |         |
| 1970-'91 .....                                                   | 31-6050   | (each) .....                                               | 50-0080 |
| 1992-'99 .....                                                   | 31-6051   | 1/4"-20 x 2 1/4" - 1979-'99 (SHCS) (H-D® #4717A)           |         |
| 2. Shaft, idler (H-D® #26327-68) .....                           | 31-6004   | (each) .....                                               | 50-0078 |
| 3. Seal, drive shaft (H-D® #26227-58) .....                      | 31-6005   | 1/4"-20 x 1 1/2" - 1979-'99 (SHCS) (H-D® #4718A)           |         |
| 4. Gear, return drive (H-D® #26315-68A) .....                    | 31-6013   | (each) .....                                               | 50-0079 |
| 5. Gear, return idler (H-D® #26317-68A) .....                    | 31-6014   | 29. Washer, 1/4" (H-D® #6099)                              |         |
| 6. Gear, supply drive (H-D® #26328-74) .....                     | 31-6015   | (each) .....                                               | 50-7017 |
| 7. Gear, supply idler (H-D® #26326-62A) .....                    | 31-6016   | (12 pack) .....                                            | 50-7013 |
| 8. Shaft, drive (H-D® #26346-70) .....                           | 31-6011   | 30. Retaining ring (H-D® #26348-36)                        |         |
| 9. Key, drive shaft (H-D® #26348-15, 26347-15)                   |           | (each) .....                                               | 50-8058 |
| (each) .....                                                     | 50-8220-S | (10 pack) .....                                            | 50-8106 |
| (10 pack) .....                                                  | 50-8229   | 31. Retaining ring, external (H-D® #11002)                 |         |
| 10. Plug, 1/8"-27 (H-D® #45830-48)                               |           | (each) .....                                               | 50-8059 |
| (each) .....                                                     | 50-8331A  | (10 pack) .....                                            | 50-8107 |
| (10 pack) .....                                                  | 50-1015   | 32. Gear, pump drive, 24T (H-D® #26345-73) .....           | 33-4230 |
| 11. Ball, check valve (H-D® #8866, 8873) .....                   | 50-8091   | 33. Gear, pinion shaft pump drive]                         |         |
| 12. Spring, check valve (H-D® #26363-36, 26363-56, 26262-80)     |           | 1939-'53 splined .....                                     | 33-4237 |
| (each) .....                                                     | 31-6022   | 1954-'89 (H-D® #26349-73, 26349-73A) .....                 | 33-4232 |
| (10 pack) .....                                                  | 31-6092   | 34. Gear, steel breather valve                             |         |
| 13. Relief valve (H-D® #26400-82, 26400-82B) .....               | 31-6082   | (See breather gears in catalog)                            |         |
| 14. Spring, relief valve (H-D® #26207-83)                        |           | 35. Shim, steel breather                                   |         |
| (each) .....                                                     | 31-6018   | (See breather shims in catalog)                            |         |
| (10 pack) .....                                                  | 31-6084   | 36. Drill jig, oil pump .....                              | 53-0013 |
| 15. Check valve & relief valve cover                             |           | 37. Plug, adjusting screw .....                            | 50-0046 |
| (each) (H-D® #26263-80, 26362-36) .....                          | 31-6021   | <b>Not Shown</b>                                           |         |
| (5 pack) .....                                                   | 31-7005   | 38. Gasket rebuild kit (N/S). Includes key, retaining ring |         |
| 16. O-ring                                                       |           | 1936-'91 .....                                             | 31-6271 |
| each (H-D® #11105, 11273) .....                                  | 50-8008   | 1992-'99 .....                                             | 31-6273 |
| (10 pack) .....                                                  | 50-8078   | 39. Primary chain oiler screw kit .....                    | 31-6291 |
| 17. Pump cover assembly                                          |           | Includes chain oiler items:                                |         |
| 1936-1992 (Top/bottom fittings, accepts pressure gauge.) .....   | 31-6059   | 1 of # 24 - Screw, chain oiler adjusting                   |         |
| 1992-'99 (Universal) .....                                       | 31-6061   | 1 of # 25 - Locknut, chain oiler                           |         |
| 1992-'99 (Bottom fittings or central supply fitting.) .....      | 31-6062   | 1 of # 26 - Washer, chain adjuster                         |         |
| 18. Fitting, front chain hose .....                              | 50-8116   | 1 of # 37 - Plug, adjusting screw                          |         |
| 19. Plug, pipe 1/16"-27 x 1/4" pipe .....                        | 50-8332   | 40. Hardware kit, oil pump cover .....                     | 31-6283 |
| 20. Elbow, supply/return (H-D® #26338-68, 26338-68A, 26561-84A)  |           | Includes oil fittings:                                     |         |
| (each) .....                                                     | 106-2682  | 3 of #10 - Plug, 1/8"-27                                   |         |
| (5 pack) .....                                                   | 50-1007   | 1 of #18 - Fitting, front chain hose                       |         |
| 21. Fitting, supply/return hose .....                            | 50-8115   | 2 of #19 - Plug, pipe 1/16"-27 x 1/4"                      |         |
| 22. Return fitting, compression (H-D® #63523-92, 63523-62) ..... | 50-8120   | 2 of #20 - Elbow, supply/return                            |         |
| 23. Seal, tubing, 3/8" x 1/2" O.D. x 1/4" Viton .....            | 50-8271   | 2 of #21 - Fitting, supply/return                          |         |
| 24. Screw, chain oiler adjusting                                 |           | 1 of #22 - Return fitting, compression                     |         |
| (H-D® #63614-72, 63610-70, 26383-32) .....                       |           | 41. Oil pump mounting hardware kit (N/S) .....             | 31-6288 |
| 31-6026 .....                                                    |           | Includes mounting bolts:                                   |         |
| 25. Locknut, chain oiler (H-D® #7634, 7638)                      |           | 2 - 1/4"-24 x 1 1/2"                                       |         |
| (each) .....                                                     | 50-5000   | 4 - 1/4"-24 x 2 1/4"                                       |         |
| 26. Washer, chain adjuster (H-D® #6156) .....                    | 50-7008   | 2 - 1/4"-20 x 1 1/2"                                       |         |
| 27. Set screw, 1/4"-20 x 1/4" .....                              | 50-0069   | 4 - 1/4"-20 x 2 1/4"                                       |         |
| 28. Screws, mounting (See Also Hardware Kit #40)                 |           | Master rebuild kit                                         |         |
| 1/4"-24 x 1 1/2" - 1936-'78 (HHCS)                               |           | 1936-'91 .....                                             | 31-6275 |
| (each) .....                                                     | 50-0082   | 1992-'99 .....                                             | 31-6278 |
| 1/4"-24 x 2 1/4" - 1936-'78 (SHCS) (H-D® #5430W)                 |           | -Includes:                                                 |         |
|                                                                  |           | Gasket rebuild kit                                         |         |
|                                                                  |           | Seal                                                       |         |
|                                                                  |           | Retaining ring                                             |         |
|                                                                  |           | Relief valve spring                                        |         |
|                                                                  |           | Check valve spring                                         |         |
|                                                                  |           | Check valve, ball                                          |         |
|                                                                  |           | Cover screw o-rings.                                       |         |

NOTE- All reference to H-D® part numbers is for identification purposes only. We in no way are implying that any of S&S Cycle's products are original equipment parts or that they are equivalent to the corresponding H-D® part number shown.

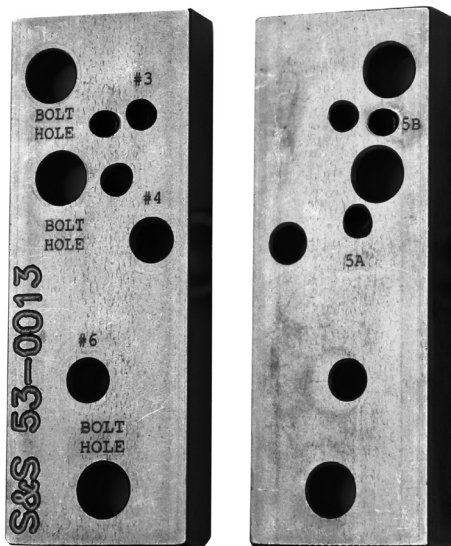
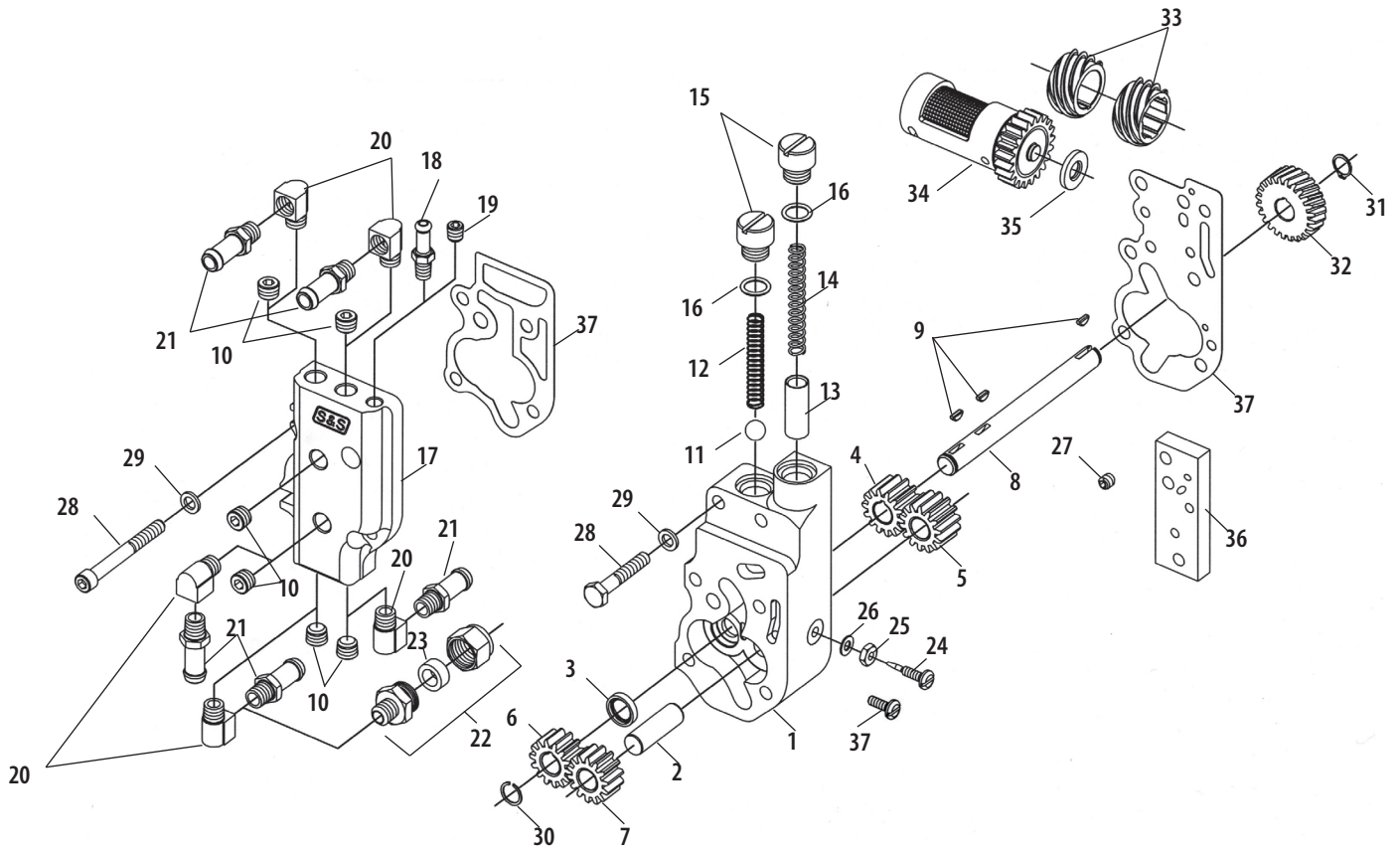

NOTE: S&S Oil Pump Drilling Jig #53-0013 has numbers by each of the drill guide holes that correspond to the steps in this instruction sheet.

## Appendix: Oil Line Routing

Most big twin oiling systems utilize three oil circuits: supply, return, and breather/vent. 1965-1984 models often utilize a fourth circuit for primary chain oiling. See **Figure 1** below. Oil line hook up for 1985-'99 engines will be similar except that no primary chain oil supply or return will be present since these models had sealed primaries.

1. Supply circuit delivers oil from tank to supply fitting in oil pump cover. Refer to Pictures 5, 6, and 7 on Pages 3 and 4. In motorcycles with oil tank located above transmission, supply fitting in oil tank is almost always located on bottom of tank at center or rear. In Harley-Davidson® Dyna®, Road King® and other models with oil tank below transmission, supply line exits oil tank on bottom of primary drive side, then crosses to cam side and connects with supply fitting on oil pump cover.
2. To distinguish oil tank's supply fitting from vent and return fittings, remove oil lines and pour small amount of oil into tank. With motorcycle in upright position, oil will flow out supply line fitting.
3. Return circuit delivers oil from return fitting in oil pump cover (Refer to Pictures 5, 6, and 7 on Pages 3 and 4), through oil filter and cooler (if applicable), to return fitting in oil tank.
4. In horseshoe-type oil tanks, two fittings nearest front of oil tank are identical. Fittings may enter through upper area of tank or connect to fittings near bottom that are attached to standpipes inside tank. These fittings are for oil return and vent lines, and in most cases may be used interchangeably, except in oil tanks with "in tank" oil filter.
5. Square oil tank used on 1965-1984 panhead and shovelhead has return line fitting in filler neck located in top center of oil tank; vent fitting is slightly forward of return fitting. In models with oil tank located below transmission, return fitting is on top of oil tank nearest center of motorcycle. Vent fitting is beside return fitting.

## ⚠ CAUTION ⚠

**Models with oil tank below transmission require precautions to prevent air from entering oil pump during oil changes if bottom oil supply fitting location (hole #4) is utilized on universal cover #31-6061. If oil lines are rubber, supply line from tank should be clamped during oil changes on these models, and clamp removed after tank has been refilled. If it is not possible to clamp lines, oil circulation must be confirmed after each oil change. It is not necessary to observe these cautions if holes 5 and 6 are used for models with oil tank below transmission.**

6. Breather or vent circuit equalizes pressure between oil tank and crankcase. See preceding paragraph for location of vent fitting in oil tank. Vent line runs from vent fitting on oil tank to Hole D in crankcase. See **Figure 1**, below.
7. Primary chain oiling system used on 1965-1984 big twin requires three oil lines. Chain oil supply line originates at 1/4" hose fitting in top of oil pump cover (See **Picture 5** page 3) and connects to 1/4" hose fitting near center of inner primary case. Primary housing vent line connects 3/8" fitting near center of inner primary cover to tee-fitting in vent line between crankcase and oil tank. Primary scavenge line connects 3/8" hose fitting at bottom, rear of inner primary cover to hole #2 (See **Picture 33**) in crankcase.

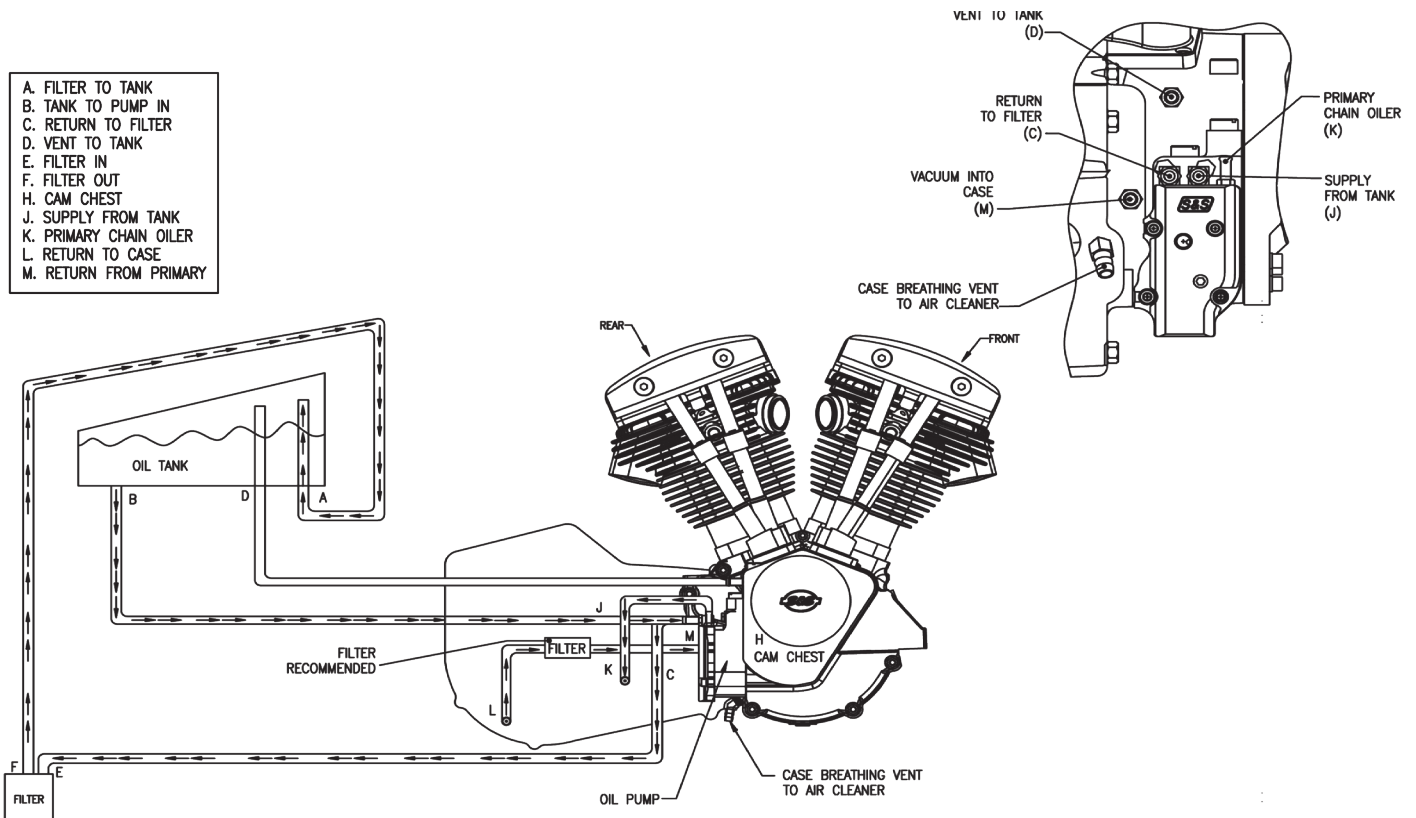

Figure 1