

Instruction 510-0420

12.03.2025

Copyright © 2016-2025

by S&S® Cycle, Inc.

All rights reserved.

Printed in the U.S.A.

S&S® Cycle, Inc.

14025 Cty Hwy G

Viola, Wisconsin 54664

Phone: 608-627-1497 • Fax: 608-627-1488

Technical Service Phone: 608-627-TECH (8324)

Technical Service Email: sstech@sscycle.com

Website: www.sscycle.com



Installation Instructions: S&S® T-Series Engine Assemblies For 2006-'17 Harley-Davidson® Dyna® Models

DISCLAIMER:

Many S&S parts are designed for high performance, closed course, racing applications and are intended for the very experienced rider only. The installation of S&S parts may void or adversely affect your factory warranty. In addition such installation and use may violate certain federal, state, and local laws, rules and ordinances as well as other laws when used on motor vehicles used on public highways. Always check federal, state, and local laws before modifying your motorcycle. It is the sole and exclusive responsibility of the user to determine the suitability of the product for his or her use, and the user shall assume all legal, personal injury risk and liability and all other obligations, duties, and risks associated therewith.

NOT LEGAL FOR SALE OR USE IN CALIFORNIA ON ANY POLLUTION CONTROLLED MOTOR VEHICLES

SAFE INSTALLATION AND OPERATION RULES:

Before installing your new S&S part, it is your responsibility to read and follow the installation and maintenance procedures in these instructions and follow the basic rules below for your personal safety.

- Gasoline is extremely flammable and explosive under certain conditions and toxic when breathed. Do not smoke. Perform installation in a well ventilated area away from open flames or sparks.
- If motorcycle has been running, wait until engine and exhaust pipes have cooled down to avoid getting burned before performing any installation steps.
- Before performing any installation steps, disconnect battery to eliminate potential sparks and inadvertent engagement of starter while working on electrical components.
- Read instructions thoroughly and carefully so all procedures are completely understood before performing any installation steps. Contact S&S with any questions you may have if any steps are unclear or any abnormalities occur during installation or operation of motorcycle with an S&S part on it.
- Consult an appropriate service manual for your motorcycle for correct disassembly and reassembly procedures for any parts that need to be removed to facilitate installation.
- Use good judgment when performing installation and operating motorcycle. Good judgment begins with a clear head. Don't let alcohol, drugs or fatigue impair your judgment. Start installation when you are fresh.
- Be sure all federal, state and local laws are obeyed with the installation.
- For optimum performance and safety and to minimize potential damage to carb or other components, use all mounting hardware that is provided and follow all installation instructions.
- Motorcycle exhaust fumes are toxic and poisonous and must not be breathed. Run motorcycle in a well ventilated area where fumes can dissipate.

IMPORTANT NOTICE:

Statements in this instruction sheet preceded by the following words are of special significance.



WARNING

Means there is the possibility of injury to yourself or others.

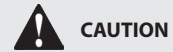

CAUTION

Means there is the possibility of damage to the part or motorcycle.

NOTE

Other information of particular importance has been placed in italic type.

S&S recommends you take special notice of these items.

WARRANTY:

All S&S parts are guaranteed to the original purchaser to be free of manufacturing defects in materials and workmanship for a period of twelve (12) months from the date of purchase. Merchandise that fails to conform to these conditions will be repaired or replaced at S&S's option if the parts are returned to us by the purchaser within the 12 month warranty period or within 10 days thereafter.

In the event warranty service is required, the original purchaser must call or write S&S immediately with the problem. Some problems can be rectified by a telephone call and need no further course of action.

A part that is suspect of being defective must not be replaced by a Dealer without prior authorization from S&S. If it is deemed necessary for S&S to make an evaluation to determine whether the part was defective, a return authorization number must be obtained from S&S. The parts must be packaged properly so as to not cause further damage and be returned prepaid to S&S with a copy of the original invoice of purchase and a detailed letter outlining the nature of the problem, how the part was used and the circumstances at the time of failure. If after an evaluation has been made by S&S and the part was found to be defective, repair, replacement or refund will be granted.

ADDITIONAL WARRANTY PROVISIONS:

- (1) S&S shall have no obligation in the event an S&S part is modified by any other person or organization.
- (2) S&S shall have no obligation if an S&S part becomes defective in whole or in part as a result of improper installation, improper maintenance, improper use, abnormal operation, or any other misuse or mistreatment of the S&S part.
- (3) S&S shall not be liable for any consequential or incidental damages resulting from the failure of an S&S part, the breach of any warranties, the failure to deliver, delay in delivery, delivery in non-conforming condition, or for any other breach of contract or duty between S&S and a customer.

Please read these instructions carefully before starting work. Proceed with the installation only after the instructions are completely understood. These instructions should be supplemented by the appropriate OEM service manual for your motorcycle. Follow all safety information.

NOTES

- S&S® T-Series Engines are designed and intended for installation in a stock Harley-Davidson® chassis. It will bolt directly to the stock transmission and engine mount.
- Installation can be performed by any repair shop equipped to do complete Harley-Davidson® engine overhauls. No special tools, other than those used in normal engine installation operations, are required.
- **ADDITIONAL OIL LINE INSTALLATION KIT REQUIRED**
S&S Part Numbers
Black 310-0870
Silver 310-0871
- **S&S® T-Series instructions often refer to procedures described in other S&S instructions or a Harley-Davidson® Service Manual. These materials should be cross-referenced as necessary.**

IMPORTANT

Before proceeding, verify that serial numbers on crankcases match numbers on packing carton and certificate of origin. Contact S&S immediately if numbers do not match.

NOTE - Valid certificate of origin is required for any transfer or sale of longblock assemblies. Certificate of origin is required to title any motorcycle.

Modification Notes

S&S® Cycle cautions against modifying these crankcases due to the possibility of damaging or weakening them. Modifying S&S crankcases in any fashion voids all manufacturer warranties. Should the customer elect to modify the crankcases regardless, it is imperative that they and the information tag attached to them be inspected beforehand to confirm that the correct model, style, bore size, etc. have been provided. The customer must confirm that crankcases and related parts are correct before assembling them or having them modified in any manner, and assumes all liability for modifications.

Under no circumstance will S&S be held responsible for expenses related to the modification of any S&S part in the event warranty service is required. Modified parts will not be accepted for credit or exchange. This will apply regardless of cause or fault: customer, retailer, manufacturer, or other.

For further information, contact S&S Technical Services at 608-627-8324, FAX 608-627-1488 or e-mail ssstech@sscycycle.com

NOTE - Modification includes but is not limited to appearance changes such as painting, powdercoating, plating, and polishing. Proper preparation for these procedures as well as the processes themselves may require the use of polishing compounds, chemicals or procedures that are potentially harmful to crankcases.

CAUTION

- **Passages and internal cavities may become obstructed by residues from materials used to polish, paint, plate or powdercoat surfaces. Additionally, surface finishing processes can damage critical machined surfaces. Any of the above may cause premature wear, damage or failure of other engine components as well as the crankcases themselves.**
- **Glass bead and polishing residues are abrasive and can be difficult to remove from recesses and small passages. Abrasive residues can cause oil contamination and extensive engine damage. Engine damage caused by powder coating, polishing, glass bead blasting, or other modification will not be covered under warranty.**

Powder Coating - Subjecting heat-treated alloys such as those used in S&S crankcases to excessive heat can drastically alter their strength and their critical properties. The degree of change depends upon the temperatures reached and the duration of exposure. When powder coating or otherwise processing alloy parts, S&S exposes them to a maximum temperature of 370°F for no longer than 20 minutes. Under no circumstances should parts be heated past 400°F!

The engine should be installed into the frame before the ignition, fuel, exhaust, and oil system components are installed.

Engine To Frame Assembly and Oil Line Kit Installation

NOTE: S&S Oil Line kits for 2006-'17 Harley-Davidson® Dyna® models are designed specifically to facilitate the installation of Dyna model specific S&S crankcases and engines. This is not a stock replacement oil pan, and will not work with stock Harley-Davidson engines.

CAUTION

Oil line installation is crucial to engine life. If you are not sure that you can properly perform this operation, please contact the S&S Tech Department for a referral to a shop in your area.

NOTE: Installation instructions are based on an engine and transmission already in the chassis with oil pan installed and inner primary removed. Engine should be installed using a new transmission to engine gasket in place to seal the oil passages utilized by the stock case. HD# 35607-06

1. Remove the stock engine from the chassis. Refer to the factory service manual for the recommended procedure.
2. Clean frame engine mounts and carefully remove any irregularities from mounting surfaces. Also inspect crankcase mounting bosses for burrs.
3. Remove the stock oil pan from the transmission, save the stock mounting screws.
4. Remove the starter from the motorcycle.

5. Block the front of the transmission up to allow access to the frame cross-member for modification.
6. Modify frame cross-member
 - a. Remove the wiring harness "fir tree" fastener from the frame cross-member and use a wire tie to fasten the wiring harness to the frame.
 - b. Using the fastener hole in the flat portion of the frame cross-member as a pilot, cut out the majority of the flat area with a 1" hole saw. See **Picture 1**.



Picture 1

- c. Use a die-grinder to remove most of the remaining flat area and blend it to the round frame tubes. See **Picture 2**.



Picture 2

- d. Use a sanding roll to smooth the edges of the remaining metal. See **Picture 3**.

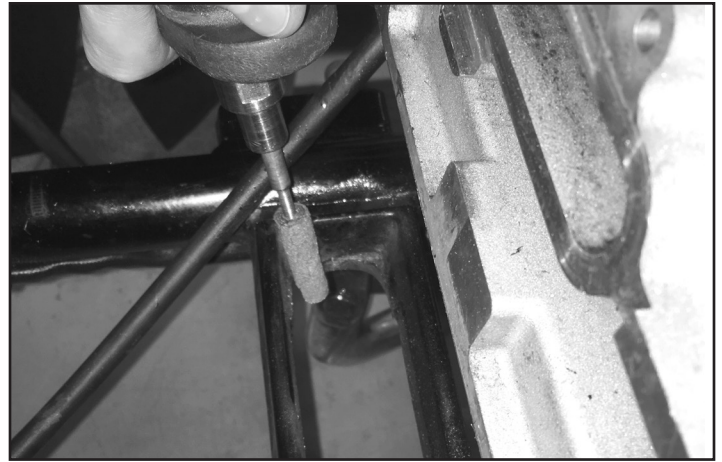

Picture 3

- e. Protect the bare metal with rust resistant paint.
7. Position S&S engine in frame, check for clearance at frame, and alignment to transmission. It is a good idea to replace rubber engine mounts at this time. Old mounts deform over time and can induce unwanted stresses on the engine case.

NOTE - The engine must be fitted to the frame it is installed into. It must rest squarely on its attachment points, and bolt solidly to the mounts without stressing the engine case at any point.

CAUTION

Failure to correctly mount the engine can cause problems not covered under warranty including but not limited to, excessive vibration, driveline mis-alignment, and broken castings.

CAUTION

Improper alignment of engine and frame mounts may cause abnormal stresses resulting in damage to crankcases or other parts.

8. When engine alignment is determined to be correct, final install in chassis. Install, starter and primary. Refer to the appropriate factory manual or engine instructions for the recommended procedures.
9. Prepare oil pan for installation.
 - a. Install both drain plugs in the S&S oil pan. See **Pictures 4 & 5**.

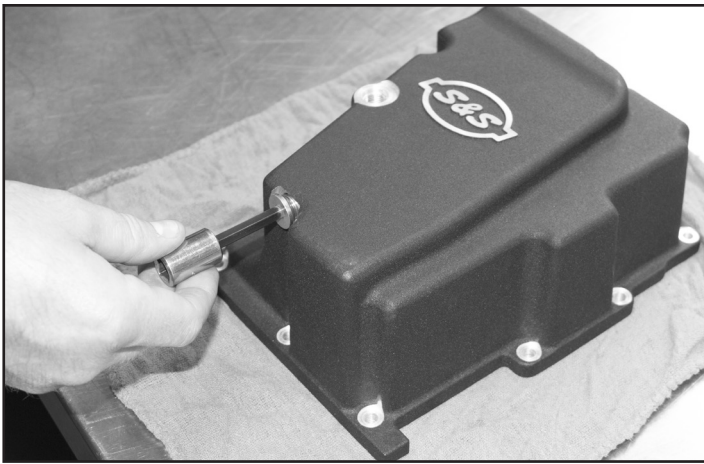

Picture 4



Picture 5

b. Lubricate o-rings and breather tube with assembly lube. Install an o-ring, a plastic washer, another o-ring, and another plastic washer in the breather tube bore of the oil pan, as shown in **Picture 6**. (Next Page).

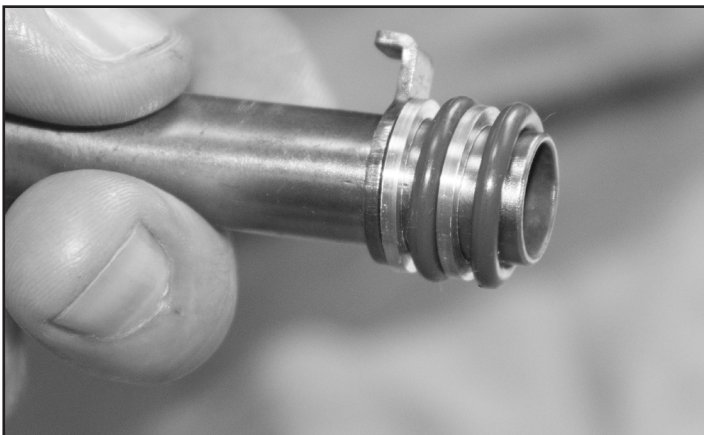

Picture 6

c. Insert the breather tube into the oil pan by rotating and pushing lightly, as shown in **Picture 7**.

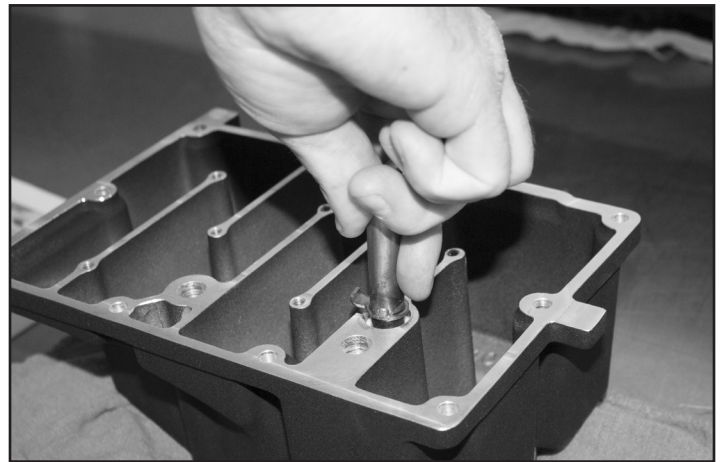

Picture 7

*NOTE: Make sure the breather tube is inserted completely and the bent tab bracket portion of the tube is below the baffle surface of the oil pan as shown in **Picture 8**.*

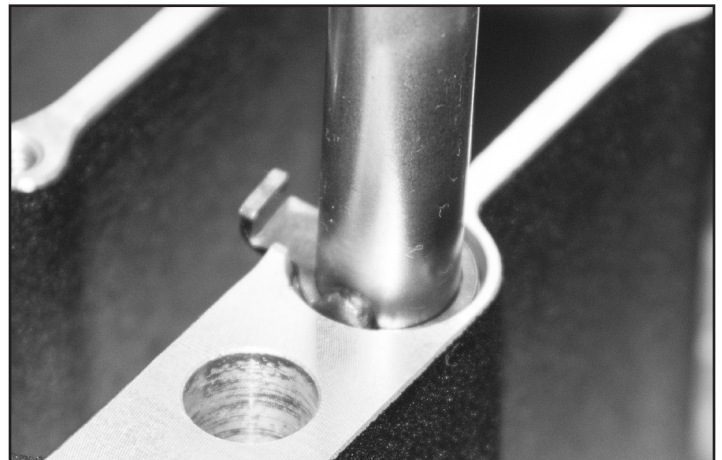

Picture 8

d. Slip the baffle plate over the breather tube as shown in **Picture 9**.



Picture 9

e. Apply red thread locker to the baffle plate screws and fasten the baffle plate to the baffle surface of the oil pan. Tighten the screws to 50 in-lb. See **Picture 10**.

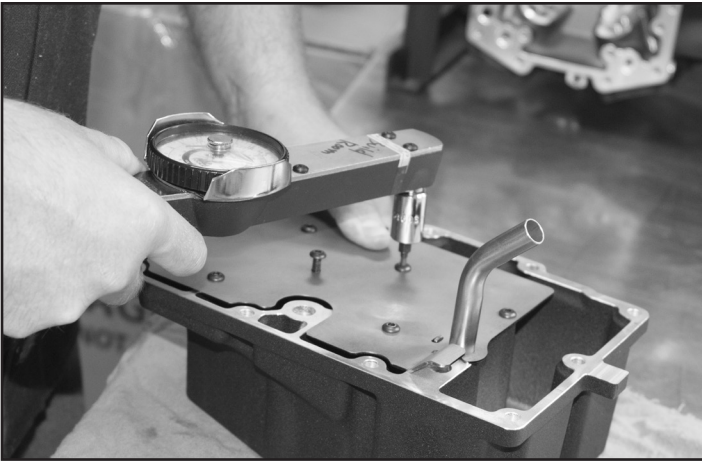

Picture 10

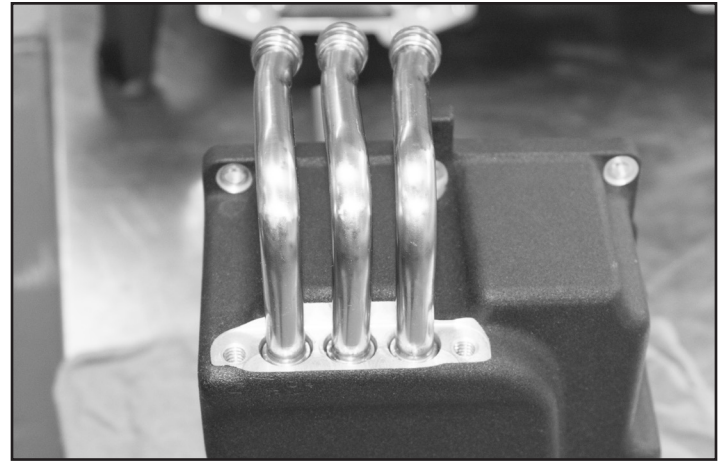

Picture 12

- f. Remove all six o-rings and plastic washers from the engine crankcase. The washers will be reused, but discard the o-rings. They will be replaced in the next step, with all new o-rings supplied in the kit.
- g. Install two o-rings and plastic washers on both ends of each of the three "L" shaped oil lines as shown in **Picture 11**. Lubricate the o-rings with assembly lube. All three "L" shaped oil lines are identical.

- i. Install the oil line retention plate. Apply blue thread locker to the 5/16"-18 X 3/4" screws and fasten the retention plate to the oil pan. Tighten screws to 15-18 ft-lb.
- j. Apply high temp gasket sealer or silicone sparingly to the gasket surface of the oil pan. Install the oil pan gasket to the oil pan, and allow it to set for a few minutes. The object of this is to keep the gasket in place while installing the oil pan.

10. Install the oil pan.

- a. Apply blue thread locker to the stock oil pan mounting bolts and to the oil line retention plate mounting bolts and set aside.
- b. Place the oil pan assembly under the motorcycle. Raise the rear end of the pan, and move it toward the engine until the rear of the pan can be inserted between the frame rails where they are farther apart. See **Picture 13**.



Picture 11

- h. Install the three oil lines in the oil line bores in the front of the oil pan with the shorter leg toward the oil pan. The longer legs will point up past the gasket surface of the oil pan. See **Picture 12**.



Picture 13

- c. Move the oil pan toward the back of the bike, raising the front of the pan. Take care that the breather tube does not hang up on the gasket surface on the front of the transmission.
- d. While raising the oil pan, insert the oil lines into the oil line bores in the S&S crankcase. The oil lines will go through the

MOTOR OIL VISCOSITY	TYPICAL AMBIENT TEMPERATURE
SAE 20W50	ABOVE 30° F (-1° C)
SAE 25W60	ABOVE 40° F (4° C)
SAE 50	ABOVE 60° F (16° C)
SAE 60	Above 80° F (27° C)

cross-member of the frame, that was modified in Step 5. See **Picture 14**.

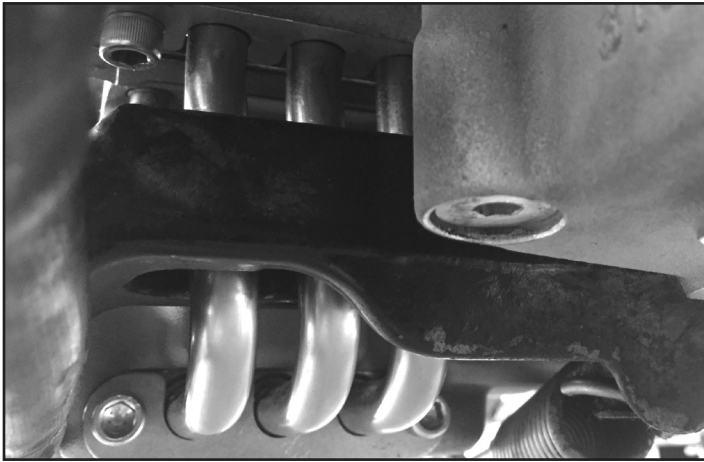

Picture 14

- e. Start several of the oil pan screws into the transmission, but do not tighten yet.
 - f. Ensure the raised bead on the oil line is flush with, or below the retention plate surface of the crankcase.
 - g. Install the oil line retention plate on the crankcase. Install the mounting screws and tighten to 15-18 ft-lb.
 - h. Install the rest of the oil pan screws and torque to 120 in-lb.
11. Reinstall any other components removed during the installation.
 12. Fill oil pan with recommended engine oil to the proper level.
 13. Remove spark plugs. Ground plug wires to cylinder head with either a jumper wire or through a test plug.
 14. Turn ignition on and turn the engine over with the starter motor until oil pressure light goes off.
 15. Verify that engine oil is returning to oil tank.

NOTES

- If oil pressure fails to indicate within 30 seconds of starter operation, allow the starter to cool. Verify that oil line routing is correct and that the oil tank is full to the proper level.
- Oil pressure indicator lamp should light when ignition is turned on. Lamp will go out after engine is started and there is oil pressure at the switch in the crankcase.

CAUTION

Avoid excessive time of starter engagement. Overheating of starter motor will result in damage. Oil pump should prime and deliver oil to the oil sender hole within 30 seconds.

Oil recommendations

NOTES

- S&S® Cycle recommends the use of S&S V-Twin 20W-50 synthetic oil in our engines.
- S&S Cycle recommends the use of S&S® oil filters, PN 31-4103 (black), or PN 31-4104 (chrome).
- Verify oiling system operation before starting

CAUTION

If engine is run with foreign material in the oil tank, engine damage will occur. Engine damage caused by foreign material in the oil tank is not covered under the S&S warranty.

CAUTION

Restricted oil flow may result in extensive engine damage not covered under warranty.

CAUTION

Improper installation of oil lines or fittings may result in parts damage not covered under warranty.

Fuel system installation

NOTES

- S&S® Engine assemblies for 2007-up big twins do not include a fuel system.
- S&S engines feature larger than stock 1.780" intake ports, which are suitable for performance intake manifolds.

1. Install fuel system.
 - a. Install throttle body, fuel injectors, and intake according to 2007-up Harley-Davidson® service manual or instructions included with any aftermarket performance fuel system.
2. Re-install and connect fuel tank.
 - a. Refer to appropriate service manual. Inspect fuel lines and clamps - replace as necessary.
 - b. Check fuel line connections and routing. Avoid hot surfaces. Make certain that the protective cover has been placed over fuel line, and that it is clear from sharp edges and abrasive surfaces.
 - c. Fill the fuel tank with a sufficient quantity of gasoline for the initial start-up procedure.
 - d. Double check that all fuel line connections have been made correctly and there is no gas leakage at any point in the system.

Note: The Harley-Davidson service manual for your model will be helpful for more specific procedures during step 3.

3. If installing a throttle by wire throttle body on a Dyna® model, clearance between fuel rail and top stabilizer link must be checked. Keep in mind that the engine will move forward and backward in operation. Minimum clearance ¼" from the top of fuel rail tab to bottom of stabilizer link is required. Fuel rail tab may need to be modified for adequate clearance. See **Picture 15**.

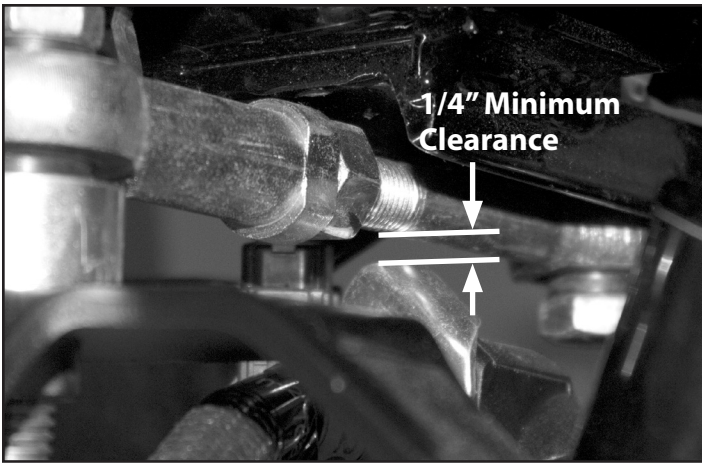

Picture 15

CAUTION

Inadequate clearance between fuel rail and motor mount could cause contact during operation, resulting in a fuel leak.

WARNING

Gasoline is extremely flammable. Leaking gasoline may result in a fire, which could cause personal injury or death.

Exhaust System

NOTE - The engine must be correctly mounted into the frame before the exhaust system is installed.

1. Place new woven-metal gasket into exhaust ports of cylinder heads.
2. Inspect the exhaust pipe header flanges and retaining rings. Replace if distorted, warped, or otherwise damaged.
3. Apply a high-temp. anti-seize lubricant to threads of exhaust studs at cylinder heads.
4. Install exhaust pipes to cylinder heads. Hand tighten exhaust stud nuts.
5. Attach exhaust to lower mounting bracket. Shim if necessary. Hand tighten mounting hardware.
6. Tighten exhaust flange nuts at head to 60-80 in-lbs.

WARNING

In some instances, brake master cylinder must be spaced out from frame to clear crankcase. UNDER NO CIRCUMSTANCES SHOULD MASTER CYLINDER OR BRAKE LINE BE ALLOWED TO CONTACT EXHAUST PIPE IN FINAL INSTALLATION. Heat transferred to brake fluid may expand and cause brakes to seize, resulting in possible fire hazard and loss of control of motorcycle with injury or death to rider and others.

NOTE - Make certain that the exhaust system is not pre-loaded, or in a bind, at the lower mounting points. Make all spacing adjustments prior to final-tightening of the upper exhaust mounting hardware at the cylinder heads. Failure to follow this procedure may cause excessive vibration and result in failure of exhaust pipes or mounting hardware.

Initial Start-Up And Engine Break-In

GENERAL BREAK-IN NOTES

- Remember that these are air-cooled engines. Sufficient air movement is required to keep engine temperatures within safe operating limits.
- Avoid heavy traffic and congestion or extended idle periods whenever possible.
- S&S v-twin performance engines are designed for, and happiest when running between 2750-3500 at normal highway speeds.
- Today's heavier bikes and taller gearing can easily push a high performance engine into a lugging condition which increases loads on engine components, causes detonation, builds excessive heat and increases fuel consumption. If the engine does not accelerate easily when given some throttle, downshift to a lower gear.
- S&S engines benefit from a warm-up period any time they are started, to get to operating temperature before being subjected to heavy loads or quick throttle revs.

BREAK-IN OIL CONSIDERATIONS.

Either petroleum or synthetic oil designed for air-cooled v-twin engines can be used during the break-in period and during normal use. If preferred, petroleum oil can be used for the break-in period, after which, the engine can be changed over to synthetic oil.

BREAK-IN PROCEDURE

1. Initial start up. Run engine approximately one minute at 1250-1750 RPM. **DO NOT** crack throttle or subject to any loads during this period as head gaskets are susceptible to failure at this time. During this time, check to see that oil pressure is normal, that oil is returning the oil tank, and that no leaks exist.
2. Shut off engine and thoroughly check for any leaks or other problems. Let engine cool to the touch.
3. After engine has cooled, start up again and allow the motor to build some heat. Engine should be run no longer than three to four minutes. When the cylinders become warm/hot to the touch (approximately 150°F) shut the motor down and let it cool to room temp. Follow the same cautions as for the initial start-up, and continue to check for problems.
4. First 50 Miles:
 - a. Street: Ride normally, do not lug the engine. Avoid high heat conditions and vary the RPM while riding. No stop and go traffic, extended idle periods, or high load or high RPM conditions. Max of 3,500 RPM or 60 MPH.
 - b. Dyno: A chassis dynamometer can be used to put the first 50 miles on a new engine. See the notes and procedure below for chassis dyno break-in.

5. 50–100 Miles: Ride normally, do not lug the engine. Avoid high heat conditions, no stop and go traffic or extended idle periods. Limited short bursts of throttle can aid in ring seating from this point forward during the break-in, but avoid continuous high speed or load conditions. Max of 4,250 RPM/70 MPH.
6. 100–500 Miles: Avoid lugging the engine and high heat conditions. Max of 5,000 RPM. Change oil at 500 miles.
7. 500–1,000 miles: Ride bike normally, but avoid continuous high load operation and high heat conditions.
8. From 1,000 miles on: Break-in is complete, enjoy!

NOTES FOR COMPLETING INITIAL 50 MILE BREAK-IN AND INITIAL TUNING ON A CHASSIS DYNO

- When running the bike on the dyno it is critical that engine temperatures are monitored, AFR is kept between 12.5–14.7 and the engine is not overheated. Fans must be used to keep the engine cool. When tuning under higher loads stop regularly and allow the engine to cool.
- A load must be placed on the engine to properly seat the rings. Running a new engine continually with no load will result in cylinder glazing and poor ring seal. The engine should be loaded to simulate close to the weight of the bike, a load of 10–15% on a Dyno jet 250i is usually sufficient. It is not recommended to use an inertia only dyno to break-in an engine as no load can be placed on the engine.
- Initial tuning on the engine can be completed during the initial 50 miles of dyno break-in. It is recommended the engine be run on the street for a minimum of 500 miles prior to completing tuning at full power. Monitor engine temperature during tuning to ensure the engine is not overheated.

DYNO BREAK-IN PROCEDURE (FIRST 50 MILES)

1. Follow the same procedure outlined above for initial start-up and heat cycling the engine.
2. Run the bike for 25 miles on the dyno under varying speeds and loads while going up and down through the gears. Keep engine RPM below 3,500 RPM but do not lug the engine. The dyno must be operated so the engine runs under a load roughly equal to the power needed to move the bike down the road, this would be about 12 hp at 55 MPH. Keep engine head temperatures below 200°F at the temp sensor or surface of the head. Stop and cool the engine if needed.
3. Allow the engine to cool down to room temperature.
4. Run the bike for 25 more miles (50 miles total) under varying speeds, loads, gears as before. Make sure there is some load on the engine. Keep engine speed below 4,250 RPM but do not lug the engine. Limited short bursts of throttle can aid in ring seating as long as the calibration/tune keeps the AFR in control. Keep engine head temperatures below 225°F at the temp sensor or surface of the head.
5. After the first 50 miles on the dyno, it is recommended the normal break-in schedule be followed under normal riding conditions on the street. See Step 5 on the previous page.

Tuning Guidelines

Ignition timing and fuel injection tuning are responsibilities of the customer. If not thoroughly familiar with these procedures, contact a professional mechanic.

1. Exhaust Systems

a. Muffled exhaust systems

If you have an existing 2-into-2 system that uses slip-on style mufflers, whether it is an OEM or an aftermarket system, we recommend S&S slip-on mufflers. S&S[®] dyno tests achieve almost 8 more horsepower and 5 ft. lbs. of torque on a stock Harley-Davidson[®] Twin Cam engine using S&S slip-on mufflers, and S&S Super Sidewinder[®] engines have produced 1-1.1 horsepower per cubic inch using stock style exhaust and S&S slip-on mufflers. These mufflers will allow your engine produce more horsepower and torque than straight-through drag pipes at low and midrange RPMs.

b. Drag pipes

While drag pipes can be used with good results to achieve top end horsepower, they are generally not recommended for low and midrange power applications. Fuel injection calibration is generally easier for engines with muffled exhaust systems.

2. Gearing

Gearing depends on the total weight of the machine and rider, the size of the engine, cam, exhaust system and type of riding. Most high performance engines, and particularly those with larger displacements, are capable of pulling more gear. We suggest you break the engine in with stock gearing to minimize the load on the engine. After the engine is broken in, you will have a better feel of its potential and can change gearing accordingly.

The following formula will determine final drive gear ratio:

$$\text{Engine Revolutions Per One Revolution of Rear Wheel} = \frac{(\text{Clutch Sprocket}^*) \times (\text{Rear Wheel Sprocket}^*)}{(\text{Motor Sprocket}^*) \times (\text{Transmission Sprocket}^*)}$$

**Number of teeth on each sprocket*

3. Service Intervals

S&S [®] RECOMMENDED REGULAR SERVICE INTERVALS	
ITEM	INTERVAL
Engine Oil & Filter	Change at 500, 2,500 miles, and every 2,500 miles thereafter. ¹
Air Cleaner	Inspect at 50 and 500 miles, every 2,500 miles thereafter. ²
Petcock, Lines, & Fittings. Vacuum Lines	Inspect at 50 and 500 miles, every 2,500 miles thereafter.
Fuel Filters	Every 5,000 miles.
Engine Idle Speed	Adjust as required.
Throttle & Enrichment Device Control	Inspect and lubricate throttle cables at 500 miles and every 2,500 miles thereafter.
Spark Plugs (Champion RA8HC or equiv.)	Inspect every 5,000 miles. Replace every 10,000 miles or as needed.
Ignition Timing - 28 deg. total advance max.	Inspect every 5,000 miles.
Engine Mounts	Inspect every 500 miles and every 5,000 miles thereafter.
External Fasteners (except cyl. head bolts)	Re-torque at 500 miles and every 5,000 miles thereafter.
¹ S&S recommends that petroleum-based oil not specifically formulated for aircooled motorcycles should be changed every 1,000 miles.	
² Replace more frequently if required or if engine is operated in a dusty environment.	

S&S Oil Line Kit Replacement Parts

1. Installation Kit, Engine, 2006-up Dyna® Wrinkle Black.....	310-0870	6. Screw, BHC, 10-24 x 1/2", Black Oxide.....	500-0520
Silver.....	310-0871	7. Tube, Breather, Bent w/ Tab, Steel, 2006-up Dyna®.....	310-0873
2. Pan, Oil, Machined, 2006-up Dyna® Wblack.....	310-0863	8. Washer, .650" x .505" x .062" Thick, Plastic, PTFE.....	500-0519
Silver.....	310-0864	9. O-ring, (-112), .487" ID x .693" OD, Viton®.....	500-0518
3. Plug, Drain, w/ O-ring, Magnetic, 1/2-20, Zinc.....	50-8335	10. Oil Line, Bent, .500" OD x .035" Wall, 2006-up Dyna®.....	310-0872
4. Gasket, Oil Pan, 2006-up Dyna®.....	310-0875	11. Clamp, Hold-Down, Oil Line, Polished, 2006-up Dyna®.....	310-0867
5. Plate, Baffle, .060" Thick, Steel, 2006-up Dyna®.....	310-0874	12. Screw, SHCS, 5/16-18 x 3/4", Zinc, ASTM A574.....	50-0302-s

