

Instruction 106-3124
8-26-08

Copyright © 2008
by S&S® Cycle, Inc.

All rights reserved.
Printed in the U.S.A.

S&S® Cycle, Inc.

235 Causeway Blvd.
La Crosse, Wisconsin 54603
Phone: 608-627-1497 • Fax: 608-627-1488
Technical Service Phone: 608-627-TECH (8324)
Technical Service Email: sstech@sscycle.com
Website: www.sscycle.com



Because every industry has a leader

Installation Instructions for X-Wedge™ Rubbermount (XW-R) Transmission Case with Engine and Swing Arm Mount

DISCLAIMER:

S&S parts are designed for high performance, off road, racing applications and are intended for the very experienced rider only. The installation of S&S parts may void or adversely affect your factory warranty. In addition such installation and use may violate certain federal, state, and local laws, rules and ordinances as well as other laws when used on motor vehicles used on public highways, especially in states where pollution laws may apply. Always check federal, state, and local laws before modifying your motorcycle. It is the sole and exclusive responsibility of the user to determine the suitability of the product for his or her use, and the user shall assume all legal, personal injury risk and liability and all other obligations, duties, and risks associated therewith.

SAFE INSTALLATION AND OPERATION RULES:

Before installing your new S&S part it is your responsibility to read and follow the installation and maintenance procedures in these instructions and follow the basic rules below for your personal safety.

- Gasoline is extremely flammable and explosive under certain conditions and toxic when breathed. Do not smoke. Perform installation in a well ventilated area away from open flames or sparks.
- If motorcycle has been running, wait until engine and exhaust pipes have cooled down to avoid getting burned before performing any installation steps.
- Before performing any installation steps disconnect battery to eliminate potential sparks and inadvertent engagement of starter while working on electrical components.
- Read instructions thoroughly and carefully so all procedures are completely understood before performing any installation steps. Contact S&S with any questions you may have if any steps are unclear or any abnormalities occur during installation or operation of motorcycle with a S&S part on it.
- Consult an appropriate service manual for your motorcycle for correct disassembly and reassembly procedures for any parts that need to be removed to facilitate installation.
- Use good judgment when performing installation and operating motorcycle. Good judgment begins with a clear head. Don't let alcohol, drugs or fatigue impair your judgment. Start installation when you are fresh.
- Be sure all federal, state and local laws are obeyed with the installation.
- For optimum performance and safety and to minimize potential damage to carb or other components, use all mounting hardware that is provided and follow all installation instructions.
- Motorcycle exhaust fumes are toxic and poisonous and must not be breathed. Run motorcycle in a well ventilated area where fumes can dissipate.

IMPORTANT NOTICE:

Statements in this instruction sheet preceded by the following words are of special significance.

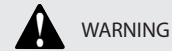

WARNING

Means there is the possibility of injury to yourself or others.



CAUTION

Means there is the possibility of damage to the part or motorcycle.

NOTE

Other information of particular importance has been placed in italic type.

S&S recommends you take special notice of these items.

WARRANTY:

All S&S parts are guaranteed to the original purchaser to be free of manufacturing defects in materials and workmanship for a period of twelve (12) months from the date of purchase. Merchandise that fails to conform to these conditions will be repaired or replaced at S&S's option if the parts are returned to us by the purchaser within the 12 month warranty period or within 10 days thereafter.

In the event warranty service is required, the original purchaser must call or write S&S immediately with the problem. Some problems can be rectified by a telephone call and need no further course of action.

A part that is suspect of being defective must not be replaced by a Dealer without prior authorization from S&S. If it is deemed necessary for S&S to make an evaluation to determine whether the part was defective, a return authorization number must be obtained from S&S. The parts must be packaged properly so as to not cause further damage and be returned prepaid to S&S with a copy of the original invoice of purchase and a detailed letter outlining the nature of the problem, how the part was used and the circumstances at the time of failure. If after an evaluation has been made by S&S and the part was found to be defective, repair, replacement or refund will be granted.

ADDITIONAL WARRANTY PROVISIONS:

- (1) S&S shall have no obligation in the event an S&S part is modified by any other person or organization.
- (2) S&S shall have no obligation if an S&S part becomes defective in whole or in part as a result of improper installation, improper maintenance, improper use, abnormal operation, or any other misuse or mistreatment of the S&S part.
- (3) S&S shall not be liable for any consequential or incidental damages resulting from the failure of an S&S part, the breach of any warranties, the failure to deliver, delay in delivery, delivery in non-conforming condition, or for any other breach of contract or duty between S&S and a customer.
- (4) S&S parts are designed exclusively for use in American v-twin motorcycles. S&S shall have no warranty or liability obligation if an S&S part is used in any other application.

**Note that the pictures used for the instructions were taken using an engine stand, not an actual frame.*

1- Insert the swing arm pivot axle through the frame and the rear of the transmission case.

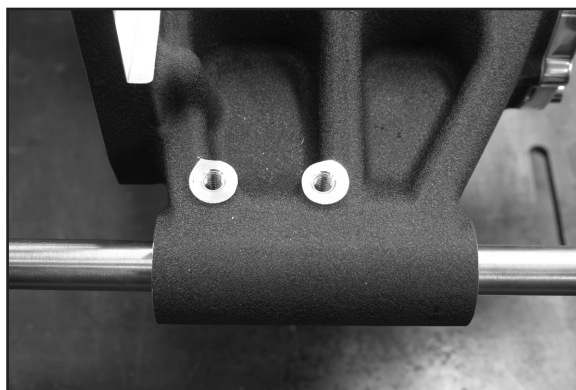

Picture 1

2- Use a jack to support the front of the transmission. Position the jack to allow clearance for the inner primary to slip on and allow access to the two mounting holes.

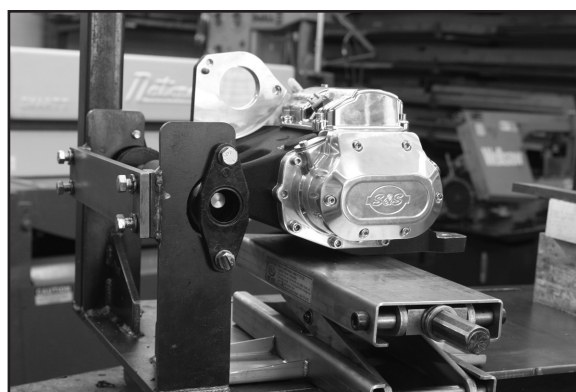

Picture 2

3- Adjust the height of the jack and get the transmission as level as possible. (If a jack is not available then blocks of wood and shims may be used to achieve this.)

4- At this point the motor may be installed into the frame.

5- Once the engine is in the frame and resting on the front engine mount and the rear engine mount is resting on the transmission case, you can line up the mounting holes and insert the front mounting bolts. Leave them loose at this point. **See Picture 3.**

Insert two front
motor mount bolts

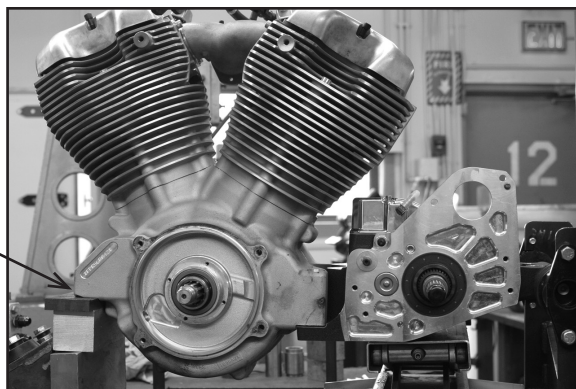

Picture 3

6- Install the supplied transmission plate with the two raised bosses facing down and placed into the counter bore of the rear mounting holes of the engine case.

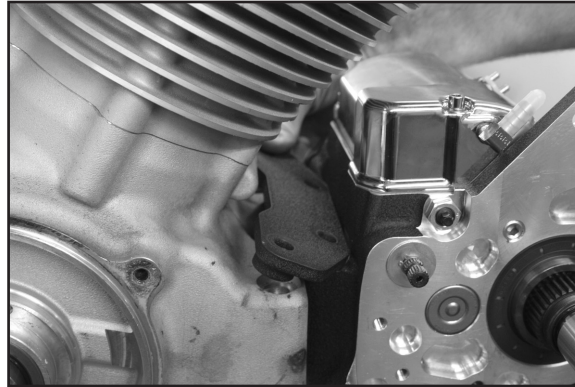

Picture 4

7- Install the four supplied bolts, washers and nuts.

NOTES:

- There are two washers for each bolt.
- Bolts must be inserted from the bottom side due to interference with the rear cylinder.

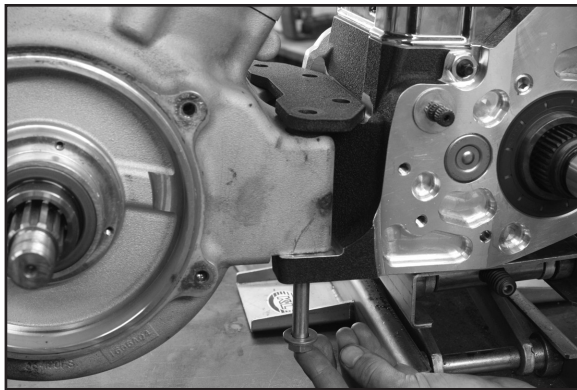

Picture 5

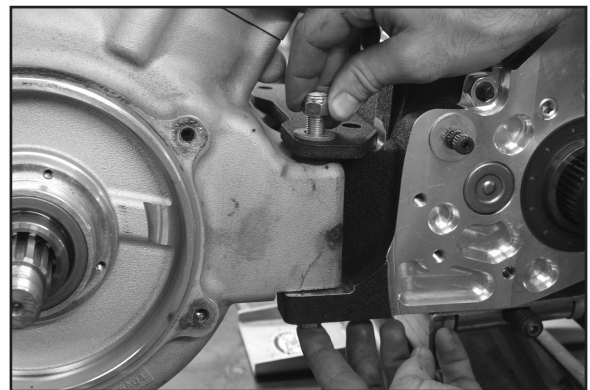

Picture 6

8- Using the jack to align the engine and transmission, carefully slip on the 1/2" engine spacer and inner primary. Do not use sealing o-rings for this alignment check.

CAUTION

Do not force the primary on or allow the inner primary to support excessive weight. Any excessive force may damage the inner primary.

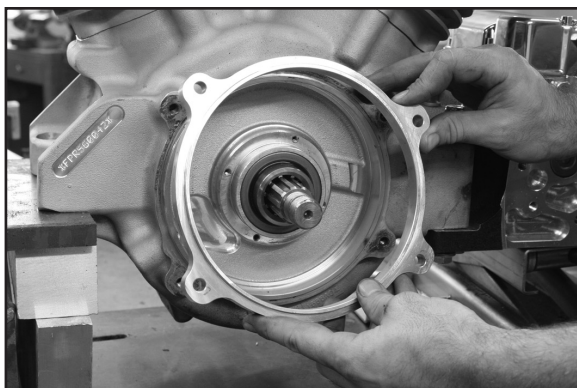

Picture 7

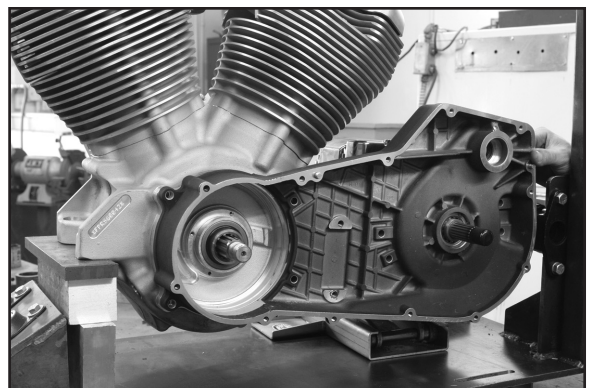

Picture 8

9- Check to make sure the surfaces of the engine, engine spacer, inner primary, and transmission mate evenly.

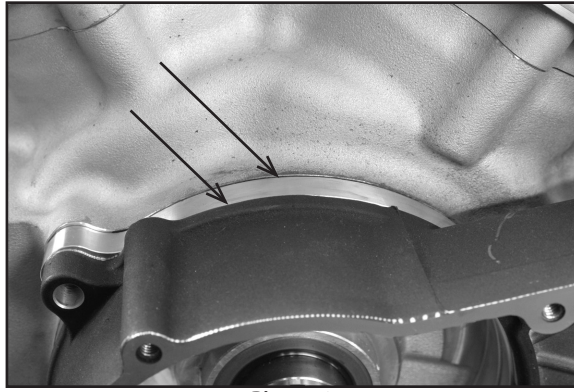

Picture 9

10- Check every bolt hole between the inner primary, engine, engine spacer, and transmission making sure they all align correctly (check areas circled below in Picture 10). If the holes do not line up correctly, adjust the height of the transmission until alignment is achieved.



Picture 10

11- Once all the bolt holes are aligned, tighten the front and rear engine mount bolts (bolts that are circled in Picture 11) to 54 ft-lbs but leave the transmission bolts loose. (Check the primary to make sure no excessive force is being applied while tightening the bolts.)

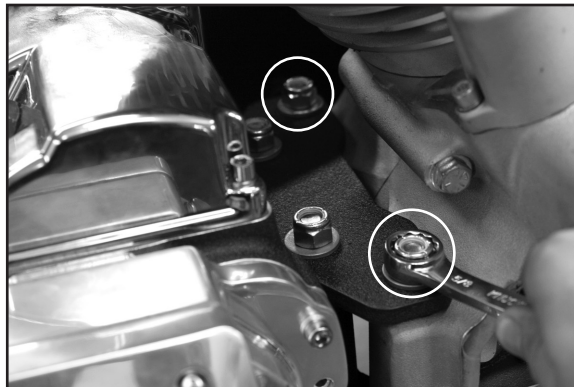

Picture 11

12- On the cam side (right side) of the bike use a feeler gauge to check the gap between the transmission plate and the top mounting surface of the transmission.

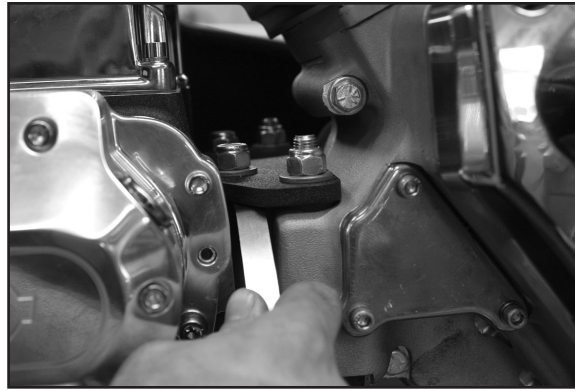

Picture 12

13- If a gap is present remove the transmission plate and insert the necessary shims on the right and left of the mounting pads of the transmission plate and the transmission.

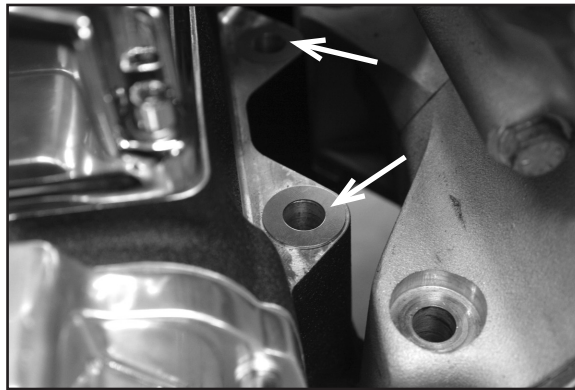

Picture 13

14- Install and tighten all four bolts to 54 ft-lbs. Use Loctite® 272™ or equivalent. Check the alignment of the primary while tightening the bolts by sliding the inner primary on and off. There should be no binding or interference.



Picture 14

15- Remove the jack and slide the inner primary back on to ensure that all the bolt holes still line up.



Picture 15

16- If the holes do not line up then reposition the jack, loosen up the transmission bolts, and repeat steps 8 through 15.

17- Check the torque of these fasteners after the initial 50 miles and again at the first oil change.

Thank you for choosing S&S products!

REPLACEMENT PARTS FOR S&S® X-WEDGE™ RUBBERMOUNT (XW-R) TRANSMISSION CASE

- 1- Shim Kit 106-3355
Two of each (.005", .010", .015" shims)
- 2- Mounting Transmission Plate
Chrome 106-3096
Black..... 106-3097
Silver 106-3098
- 3- Hardware Kit, (4 bolts, 8 washers, 4 nuts)..... 106-3359

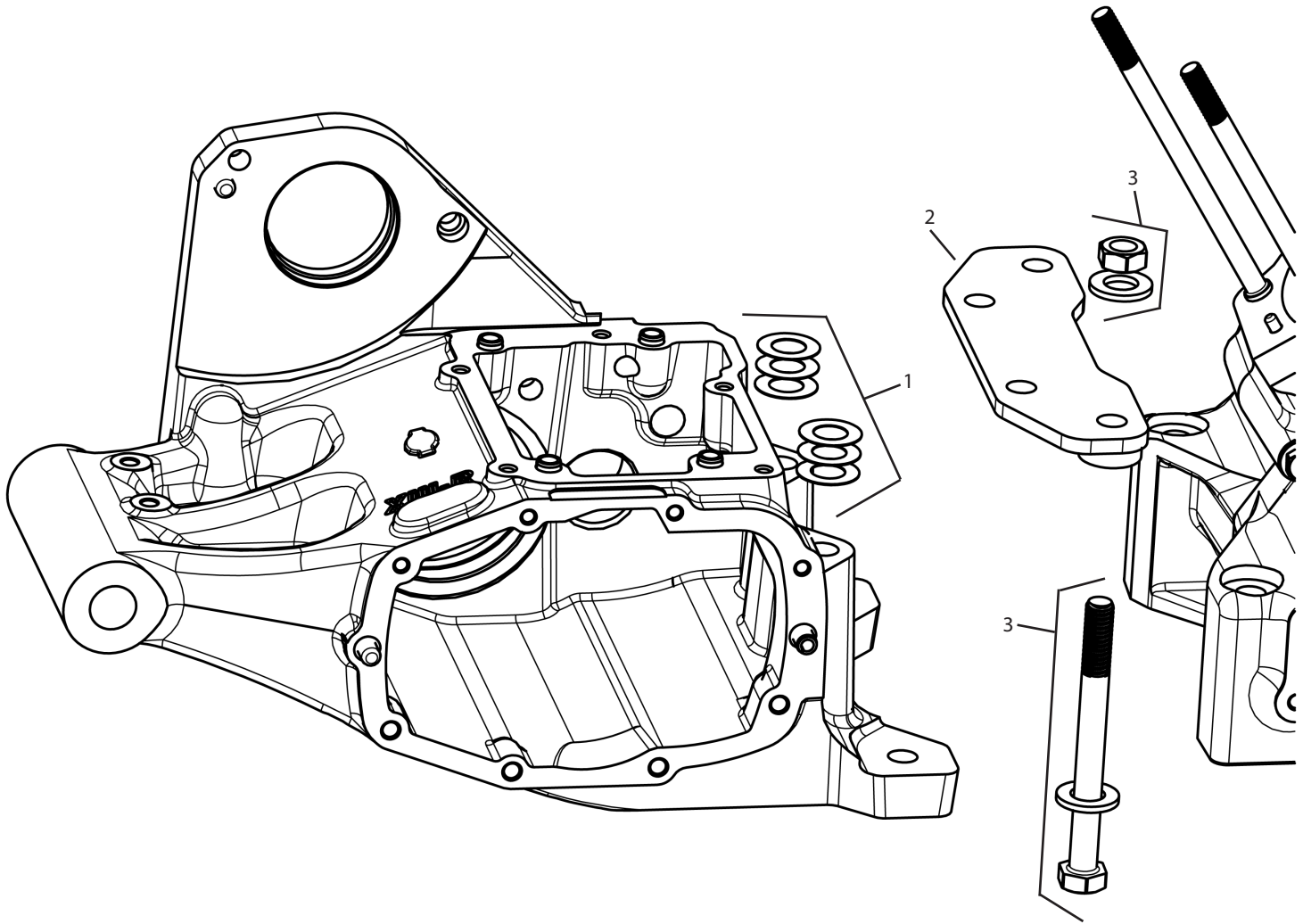



Because every industry has a leader